



REFRIGERATION AND
AIR CONDITIONING

INSTRUCTIONS

EKC 202A (115 V)

EKC 202B (115 V)

EKC 202C (115 V)



084R9976



R18KL45J

084R9976

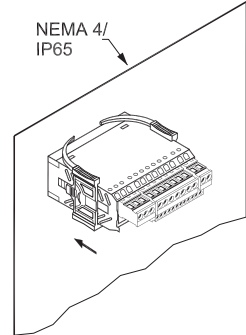
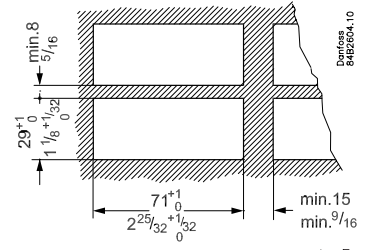
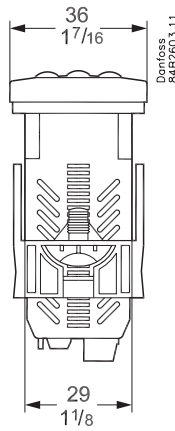
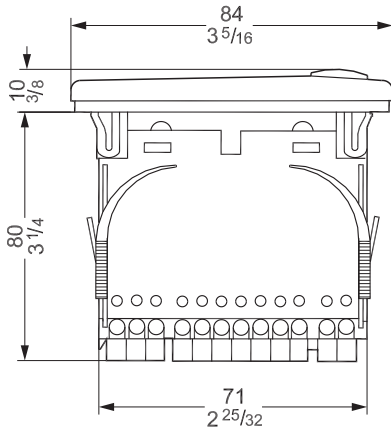

NEMA 4/
IP65

$t_{amb} = 0 - +55^{\circ}\text{C}$

115 V a.c.

50/60 Hz

2.0 VA

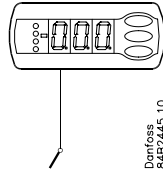

Type: Pt 1000 (1000 Ω / 0°C) /
Ptc 1000 (1000 Ω / 25°C) /
NTC-M2020 (5000 Ω / 25°C)

($\phi 06$)

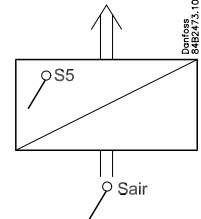

10 V < U < 256 V

	CE (250 V a.c.)	UL *** (240 V a.c.)
DO1. Refrigeration *	10 (6) A	10 A Resistive 5FLA, 30LRA
DO2. Defrost *	10 (6) A	10 A Resistive 5FLA, 30LRA
DO3. Fan *	6 (3) A	6 A Resistive 3FLA, 18LRA 131 VA Pilot duty
DO4. Alarm, light or rail heat *	4 (1) A Min. 100 mA**	4 A Resistive 131 VA Pilot duty

* DO1 and DO2 are 16 A relays. DO3 and DO4 are 8 A relays. Max. load must be kept.
** Gold plating ensures make function with small contact loads
*** UL-approval based on 30000 couplings

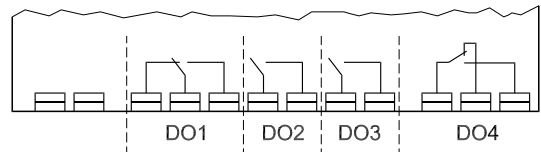

Data communication LON RS 485 / MOD-bus:

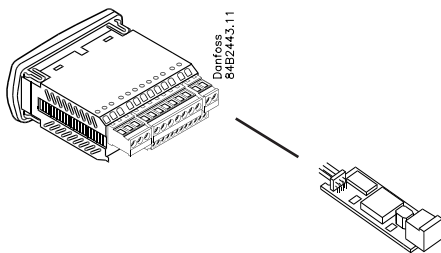

LON

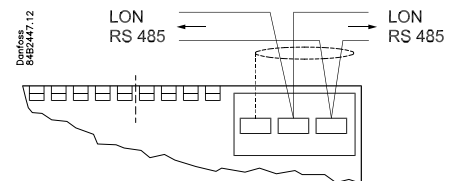

MOD-bus

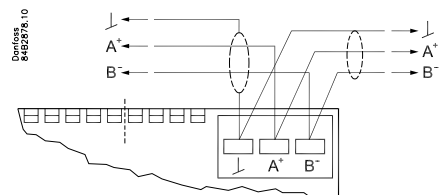

084R9976

EKC 202A

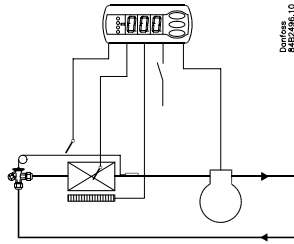

Danfoss
84B200.10

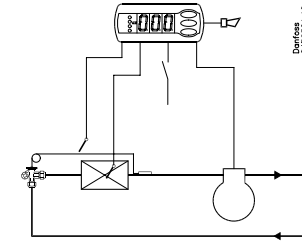

Danfoss
84B200.10

*) AU:
Gold, Or, Oro
 $\ell = \text{max. } 15 \text{ m}$

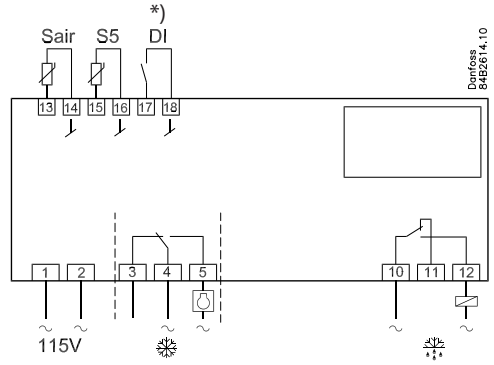

Danfoss
84B201.10

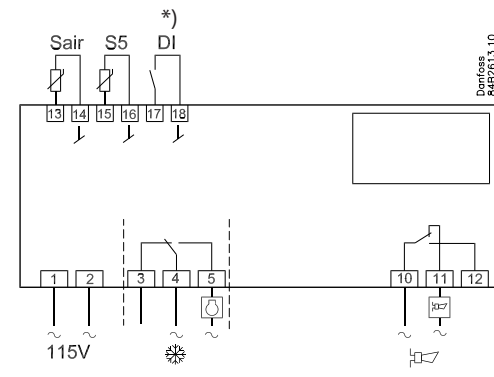

Danfoss
84B201.10

EKC 202B

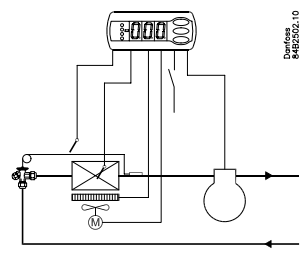

Danfoss
84B202.10

*) AU:
Gold, Or, Oro
 $\ell = \text{max. } 15 \text{ m}$

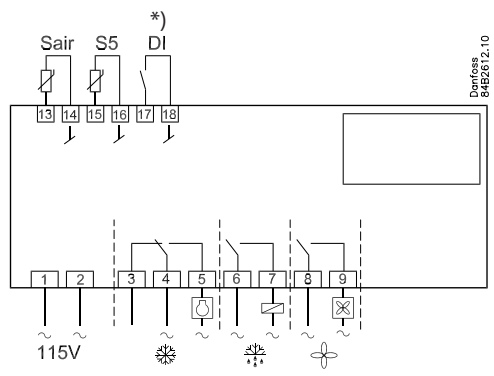

Danfoss
84B202.10

EKC 202C

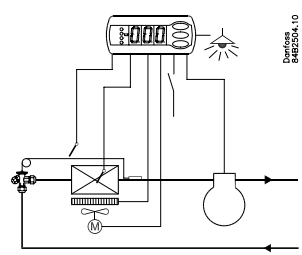

Danfoss
84B204.10

*) AU:
Gold, Or, Oro
 $\ell = \text{max. } 15 \text{ m}$

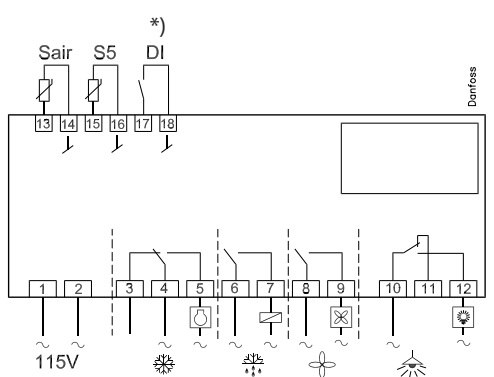

Danfoss

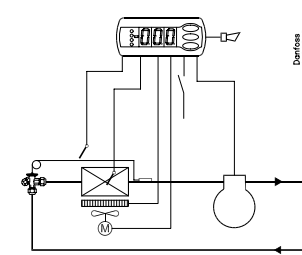

Danfoss
84B204.10

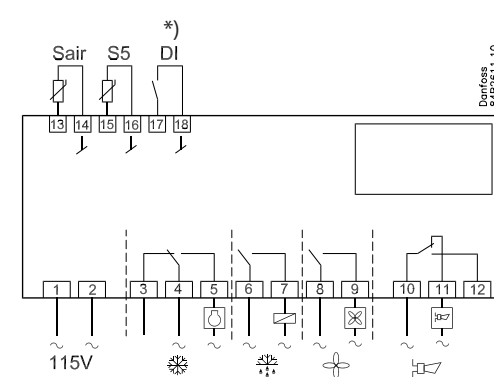

Danfoss
84B201.10

English

The buttons

Set menu

1. Push the upper button until a parameter is shown
2. Push the upper or the lower button and find that parameter you want to change
3. Push the middle button until the parameter value is shown
4. Push the upper or the lower button and select the new value
5. Push the middle button again to enter the value.

Set temperature

1. Push the middle button until the temperature value is shown
2. Push the upper or the lower button and select the new value
3. Push the middle button to select the setting.

Reading the temperature at sensor S5

- Push briefly the lower button

Manual start or stop of a defrost

- Push the lower button for four seconds.

Light emitting diode

 = refrigeration

 = defrost

 = fan running

Flashes fast at alarm

Cutout alarm relay / see alarm code

- Push briefly the upper button

Start-up:

Regulation starts when the voltage is on.

- 1 Go through the survey of factory settings. Make any necessary changes in the respective parameters.
- 2 For network. Set the address in o03 and then transmit it to the gateway/system unit with setting o04.

SW = 1.3x

Function	Parameters	Codes	Controller			Min.-value	Max.-value	Factory setting	Actual setting
			EKC 202A	EKC 202B	EKC 202C				
Normal operation									
Temperature (set point)		---				-50°C	50°C	2°C	
Thermostat									
Differential		r01				0,1 K	20 K	2 K	
Max. limitation of setpoint setting		r02				-49°C	50°C	50°C	
Min. limitation of setpoint setting		r03				-50°C	49°C	-50°C	
Adjustment of temperature indication		r04				-20 K	20 K	0.0 K	
Temperature unit (°C/°F)		r05				°C	°F	°C	
Correction of the signal from Sair		r09				-10 K	10 K	0 K	
Manual service(-1), stop regulation(0), start regulation (1)		r12				-1	1	1	
Displacement of reference during night operation		r13				-10 K	10 K	0 K	
Activation of reference displacement r40		r39				OFF	on	OFF	
Value of reference displacement (can be activated by r39 or DI)		r40				-50 K	50 K	0 K	
Alarm									
Delay for temperature alarm		A03				0 min	240 min	30 min	
Delay for door alarm		A04				0 min	240 min	60 min	
Delay for temperature alarm after defrost		A12				0 min	240 min	90 min	
High alarm limit		A13				-50°C	50°C	8°C	
Low alarm limit		A14				-50°C	50°C	-30°C	
Alarm delay DI1		A27				0 min	240 min	30 min	
High alarm limit for condenser temperature (o70)		A37				0°C	99°C	50°C	
Compressor									
Min. ON-time		c01				0 min	30 min	0 min	
Min. OFF-time		c02				0 min	30 min	0 min	
Compressor relay must cutin and out inversely (NC-function)		c30				0 / OFF	1 / on	0 / OFF	
Defrost									
Defrost method (none/EL/gas)		d01				no	gas	EL	
Defrost stop temperature		d02				0°C	25°C	6°C	
Interval between defrost starts		d03				0 hours	48 hours	8 hours	
Max. defrost duration		d04				0 min	180 min	45 min	
Displacement of time on cutin of defrost at start-up		d05				0 min	240 min	0 min	
Drip off time		d06				0 min	60 min	0 min	
Delay for fan start after defrost		d07				0 min	60 min	0 min	
Fan start temperature		d08				-15°C	0°C	-5°C	
Fan cutin during defrost		d09				0	2	1	
0: Stopped 1: Running 2: Running during pump down and defrost									
Defrost sensor (0=time, 1=S5, 2=Sair)		d10				0	2	0	
Max. aggregate refrigeration time between two defrosts		d18				0 hours	48 hours	0 hours	
Defrost on demand - S5 temperature's permitted variation during frost build-up. On central plant choose 20 K (=off)		d19				0 K	20 K	20 K	
Fans									
Fan stop at cutout compressor		F01				no	yes	no	
Delay of fan stop		F02				0 min	30 min	0 min	
Fan stop temperature (S5)		F04				-50°C	50°C	50°C	
Real time clock									
Six start times for defrost. Setting of hours. 0=OFF		t01-t06				0 hours	23 hours	0 hours	
Six start times for defrost. Setting of minutes. 0=OFF		t11-t16				0 min	59 min	0 min	
Clock - Setting of hours		t07				0 hours	23 hours	0 hours	
Clock - Setting of minute		t08				0 min	59 min	0 min	

Clock - Setting of date	t45				1	31	1	
Clock - Setting of month	t46				1	12	1	
Clock - Setting of year	t47				0	99	0	
Miscellaneous								
Delay of output signals after start-up	o01				0 s	600 s	5 s	
Input signal on DI1. Function: 0=not used. 1=status on DI1. 2=door function with alarm when open. 3=door alarm when open. 4=defrost start (pulse-pressure). 5=ext.main switch. 6=night operation 7=change reference (activate r40). 8=alarm function when closed. 9=alarm function when open. 10=case cleaning (pulse pressure). 11=Inject off when open.	o02				0	11	0	
Network address	o03				0	119	0	
On/Off switch (Service Pin message)	o04				OFF	ON	OFF	
Access code 1 (all settings)	o05				0	100	0	
Used sensor type (Pt /PTC/NTC)	o06				Pt	ntc	Pt	
Display step = 0.5 (normal 0.1 at Pt sensor)	o15				no	yes	no	
Max hold time after coordinated defrost	o16				0 min	60 min	20	
Configuration of light function (relay 4) 1=ON during day operation. 2=ON / OFF via data communication. 3=ON follows the DI-function, when DI is selected to door function or to door alarm	o38				1	3	1	
Activation of light relay (only if o38=2)	o39				OFF	ON	OFF	
Case cleaning. 0=no case cleaning. 1=Fans only. 2=All output Off.	o46				0	2	0	
Access code 2 (partly access)	o64				0	100	0	
Save the controllers present settings to the programming key. Select your own number.	o65				0	25	0	
Load a set of settings from the programming key (previously saved via o65 function)	o66				0	25	0	
Replace the controllers factory settings with the present settings	o67				OFF	On	OFF	
Select application for S5 sensor (0=defrost sensor, 1= product sensor, 2=condenser sensor with alarm)	o70				0	2	0	
Select application for relay 4: 1=defrost/light, 2= alarm	o72	defrost / Alarm		Light / Alarm	1	2	2	
Service								
Temperature measured with S5 sensor	u09							
Status on DI1 input. on/1=closed	u10							
Status on night operation (on or off) 1=closed	u13							
Read the present regulation reference	u28							
Status on relay for cooling (Can be controlled manually, but only when r12=-1)	u58							
Status on relay for fans (Can be controlled manually, but only when r12=-1)	u59							
Status on relay for defrost. (Can be controlled manually, but only when r12=-1)	u60							
Temperature measured with Sair sensor	u69							
Status on relay 4 (alarm, defrost, light).(Can be controlled manually, but only when r12=-1)	u71							

Factory setting

If you need to return to the factory-set values, it can be done in this way:

- Cut out the supply voltage to the controller
- Keep upper and lower button depressed at the same time as you reconnect the supply voltage

Fault code display		Alarm code display		Status code display	
E1	Fault in controller	A 1	High temperature alarm	S0	Regulating
E6	Change battery + check clock	A 2	Low temperature alarm	S1	Waiting for end of the coordinated defrost
E 27	S5 sensor error	A 4	Door alarm	S2	ON-time Compressor
E 29	Sair sensor error	A 5	Max. Hold time	S3	OFF-time Compressor
		A 15	DI 1 alarm	S4	Drip-off time
		A 45	Standby mode	S10	Refrigeration stopped by main switch
		A 59	Case cleasning	S11	Refrigeration stopped by thermostat
		A 61	Condenser alarm	S14	Defrost sequence. Defrosting
				S15	Defrost sequence. Fan delay
				S16	Refrigeration stopped. (open DI input)
				S17	Door open (open DI input)
				S20	Emergency cooling
				S25	Manual control of outputs
				S29	Case cleaning
				S32	Delay of output at start-up
				non	The defrost temperature cannot be displayed. There is stop based on time
				-d-	Defrost in progress / First cooling after defrost
				PS	Password required. Set password

Los botones

Ajustar parámetros

1. Pulsar el botón superior hasta que aparece el parámetro r01.
2. Pulsar los botones alto y bajo hasta encontrar el parámetro deseadido.
3. Pulsar el botón central para ver el valor actual.
4. Pulsar los botones alto y bajo para modificar el valor.
5. Pulsar el botón central para confirmar el nuevo valor.

Ajustar la temperatura de corte

1. Pulsar el botón central para ver el valor actual.
2. Pulsar los botones alto y bajo para modificar el valor.
3. Pulsar el botón central para confirmar el nuevo valor.

Leer la temperatura de la sonda S5

- Pulsar y soltar el botón bajo

Iniciar/parar un desescarche manualmente

- Pulsar y mantener el botón bajo durante 4s.

LED's en el display

 = refrigeración

 = desescarche

 = ventiladores

Parpadean cuando hay una alarma

Rearmar el relé de alarma / ver el código de alarma

- Pulsar y soltar el botón alto

Puesta en marcha:

El equipo comienza a funcionar cuando se aplica alimentación eléctrica.

1 Revisar la programación por defecto (ver Menú de Parámetros) y ajustar los parámetros oportunos.

2 Si el equipo está conectado a un bus de comunicaciones, ajustar la dirección en o03 y enviar la dirección a la Gateway con o04.

SW = 1.3x

Función	Parámetros	Código	Controlador			Valor - mín.	Valor - máx.	Ajuste fábrica	Ajuste actual
			EKC 202A	EKC 202B	EKC 202C				
Funcionamiento normal									
Temperatura de corte (set point)		---				-50°C	50°C	2°C	
Termostato									
Diferencial del termostato		r01				0,1 K	20 K	2 K	
Límite máximo al ajustar la temperatura de corte		r02				-49°C	50°C	50°C	
Límite mínimo al ajustar la temperatura de corte		r03				-50°C	49°C	-50°C	
Corrección de la temperatura en el display		r04				-20 K	20 K	0,0 K	
Unidades de temperatura (°C/°F)		r05				°C	°F	°C	
Calibración de la sonda Saire		r09				-10 K	10 K	0 K	
Marcha/paro interno: -1: modo manual, 0: EKC parado, 1: en marcha		r12				-1	1	1	
Desplazamiento de la temp. de corte durante la noche		r13				-10 K	10 K	0 K	
Activar el incremento de la temperatura de corte		r39				OFF	on	OFF	
Incremento de la temperatura de corte (grados) (activación por r39 o DI)		r40				-50 K	50 K	0 K	
Alarma									
Retardo de alarma de temperatura (estándar)		A03				0 min	240 min	30 min	
Retardo de alarma de puerta		A04				0 min	240 min	60 min	
Retardo de alarma de temperatura (después de desescarche)		A12				0 min	240 min	90 min	
Límite de alarma por alta temperatura		A13				-50°C	50°C	8°C	
Límite de alarma por baja temperatura		A14				-50°C	50°C	-30°C	
Retardo de la alarma asociada a DI		A27				0 min	240 min	30 min	
Límite de alarma por alta temperatura del condensador (con S5 y o70 = 2)		A37				0°C	99°C	50°C	
Compresor									
Mínimo tiempo de compresor en marcha (minutos)		c01				0 min	30 min	0 min	
Mínimo tiempo de entre dos arranques consecutivos (minutos)		c02				0 min	30 min	0 min	
Invertir el funcionamiento de la salida DO1 (compresor)		c30				0 / OFF	1 / on	0 / OFF	
Desescarche									
Tipo de desescarche (OFF/EL/gas)		d01				no	gas	EL	
Temperatura fin de desescarche		d02				0°C	25°C	6°C	
Intervalo de tiempo entre desescarches		d03				0 horas	48 horas	8 horas	
Duración máxima del desescarche		d04				0 min	180 min	45 min	
Desplazamiento del 1º desescarche tras dar tensión al equipo		d05				0 min	240 min	0 min	
Tiempo de goteo		d06				0 min	60 min	0 min	
Retardo del ventilador tras el desescarche		d07				0 min	60 min	0 min	
Temperatura arranque del ventilador		d08				-15°C	0°C	-5°C	
Ventilador en marcha durante desescarche (no/yes)		d09				0	2	1	
0: parado									
1: en marcha									
2: en marcha durante el vaciado y el desescarche									
Sonda de fin de desescarche (0=no (tiempo), 1=S5, 2=Saire)		d10				0	2	0	
Desescarche bajo demanda: tiempo acumulado refrigerando (0=Función cancelada)		d18				0 horas	48 horas	0 horas	
Desescarche bajo demanda: variación permitida a S5 (20 = Función cancelada)		d19				0 K	20 K	20 K	
Ventiladores									
Parar ventilador al parar compresor (yes/no)		F01				no	yes	no	
Retardo de parada del ventilador		F02				0 min	30 min	0 min	
Temperatura de paro del ventilador (medida con S5)		F04				-50°C	50°C	50°C	
Reloj de tiempo real									
Hasta seis horas (hh) de inicio de desescarche. 0=OFF		t01-t06				0 horas	23 horas	0 horas	
Los minutos (mm) de cada una de las 6 horas. 0=OFF		t11-t16				0 min	59 min	0 min	
Ajuste del reloj - hora		t07				0 horas	23 horas	0 horas	
Ajuste del reloj - minutos		t08				0 min	59 min	0 min	

Ajuste del reloj - día	t45				1	31	1	
Ajuste del reloj - mes	t46				1	12	1	
Ajuste del reloj - año	t47				0	99	0	
Varios								
Retardo de activación de salidas al dar tensión al equipo	o01				0 s	600 s	5 s	
Función de la entrada digital DI1: 0=no utilizada. 1=comunica el estado de DI1. 2=puerta abierta y alarma. 3=sólo la alarma de puerta. 4=pulso para iniciar un desescarche. 5=interruptor principal. 6=operación nocturna 7=desplazamiento temperatura de corte (activación r40). 8=alarma al cerrar el contacto 9=alarma al abrir el contacto. 10=limpieza del mueble (pulso). 11= Inject off al abrir el contacto.	o02				0	11	0	
Dirección del EKC	o03				0	240	0	
Enviar la dirección del EKC a la gateway	o04				OFF	ON	OFF	
Código 1 de acceso a todos los parámetros (0= código desactivado)	o05				0	100	0	
Tipo de las sondas utilizadas (Pt /PTC/NTC)	o06				Pt	ntc	Pt	
Precisión del valor del display: yes = 0.5, no = 0,1	o15				no	yes	no	
Máximo tiempo de espera tras un desescarche coordinado (sólo vía gateway)	o16				0 min	60 min	20	
Función de luz (relé 4; ver parámetro o72) 1=ON durante operación día. 2=ON / OFF vía bus de comunicaciones. 3=ON a la vez que la DI cuando esa DI es para la función de puerta o alarma de puerta.	o38				1	3	1	
Activación del relé de luz vía bus de comunicaciones (sólo si o38=2)	o39				OFF	ON	OFF	
Limpieza del mueble. 0=no activo. 1=Sólo ventilador en ON. 2= Todas las salidas en OFF.	o46				0	2	0	
Código 2 de acceso a parte de los parámetros (0=desactivar código)	o64				0	100	0	
Guardar la programación de un EKC en una "copy-key".	o65				0	25	0	
Volcar la programación desde una "copy-key" a un EKC	o66				0	25	0	
Sustituir los "ajustes de fábrica" por la programación actual	o67				OFF	On	OFF	
Función de la sonda S5: 0 = desescarche, 1 = producto, 2 = alarma temp. condensador	o70				0	2	0	
Función del relé 4: 1=desescarche (EKC 202A) o luz (EKC 202C), 2= alarma	o72	Desesc. / Alarma		Luz / Alarma	1	2	2	
Parámetros informativos (servicio).								
Temperatura medida con la sonda S5	u09							
Estado de la entrada DI. (OFF = contacto abierto / ON = contacto cerrado)	u10							
Estado de la operación nocturna (OFF = no activa / ON = activa)	u13							
Temperatura de corte (set-point)	u28							
Estado del relé de frío (0/off = desactivado, 1/on = activado)*	u58							
Estado del relé del ventilador (0/off = desactivado, 1/on = activado)*	u59							
Estado del relé de desescarche (0/off = desactivado, 1/on = activado)*	u60							
Temperatura medida con la sonda Saire	u69							
Estado del relé 4 (0/off = desactivado, 1/on = activado)*	u71							

*) Pueden operarse manualmente si r12= -1

Ajustes de fábrica

Si se necesita volver a la programación de fábrica, se procederá así:

- Se corta la alimentación eléctrica al EKC
- Se restablece la alimentación eléctrica mientras se mantienen pulsados los botones alto y bajo durante unos segundos.

Código de fallos		Códigos de alarma		Códigos de estado	
E1	Fallo del controlador	A 1	Alarma por alta temperatura de aire	S0	Enfriando
E6	Fallo reloj (comprobar pila y "resetear" reloj)	A 2	Alarma por baja temperatura de aire	S1	Esperando final de desescarche coordinado.
E 27	Error en la sonda S5	A 4	Alarma de puerta	S2	Compresor dentro del mín. tiempo en marcha.
E 29	Error en la sonda Saire	A 5	Expirada la espera tras desescarche coordinado	S3	Compresor mín. tiempo entre arranques consecutivos.
		A 15	Alarma asociada a DI	S4	Tiempo de goteo en curso.
		A 45	EKC parado (ya sea por r12 ó por la DI)	S10	Equipo parado (desde r12 ó desde DI)
		A 59	Limpieza del mueble	S11	Refrigeración parada. (Se ha alcanzado la temperatura de corte).
		A 61	Alarma de temperatura del condensador	S14	Desescarchando
				S15	Retraso del ventilador tras desescarche.
				S16	Refrigeración parada. (entrada DI abierta)
				S17	Puerta abierta
				S20	Refrigeración en emergencia.
				S25	Control manual, forzado, activo.
				S29	Limpieza del mueble
				S32	Retraso inicial al dar tensión al equipo.
				non	No se puede mostrar la temperatura de desescarche. No hay sonda.
				-d-	Se está realizando un desescarche.
				PS	PS: introduzca contraseña (Código de acceso)

