

AKO-55323 AKO-55123 AKO-55120

Alarma de hombre encerrado
Trapped person alarm
Alarme de personne enfermée
Personennotruf für Kühlräume

Manual de usuario / User Manual / Manuel d'utilisateur /
Benutzerhandbuch / Manual de utilizador



Índice	Pág
Versiones y referencias	3
Advertencias	3
Descripción del equipo.....	4
Instalación	5
Conexionado	6
Configuración.....	8
Funcionamiento.....	7
Mantenimiento.....	7
Conectividad	8
Especificaciones técnicas	9
Accesorios.....	9

AKO Electromecànica, le agradece y felicita por la adquisición de nuestro producto, en cuyo desarrollo y fabricación se han utilizado las tecnologías más innovadoras, así como unos rigurosos procesos de producción y control de calidad.

Nuestro compromiso por conseguir la satisfacción de nuestros clientes y el continuo esfuerzo por mejorar día a día lo constatan las diversas certificaciones de calidad obtenidas.

Este es un producto de altas prestaciones y tecnológicamente avanzado. De su correcta planificación, instalación, configuración y puesta en marcha, dependerá en gran medida su funcionamiento, así como las prestaciones finales alcanzadas. Lea detenidamente este manual antes de proceder a instalarlo, y respete en todo momento las indicaciones del mismo.

Únicamente personal cualificado puede instalar o realizar la asistencia técnica del producto.

Este producto ha sido desarrollado para su utilización en las aplicaciones descritas en su manual, AKO Electromecànica no garantiza su funcionamiento en cualquier utilización no prevista en dicho documento, así como no se responsabilizará en ningún caso de los daños de cualquier tipo que pudiera ocasionar una utilización, configuración, instalación o puesta en marcha incorrectas.

Es responsabilidad del instalador y del cliente el cumplir y hacer cumplir las normativas aplicables a las instalaciones donde se destinarán nuestros productos. AKO Electromecànica no se responsabilizará de los daños que puedan ocasionar el incumplimiento de las mismas. Siga rigurosamente las indicaciones descritas en este manual.

De cara a alargar el máximo posible la vida de nuestros equipos, se deben cumplir las siguientes observaciones:

- No exponga los equipos electrónicos al polvo, suciedad, agua, lluvia, humedad, temperaturas elevadas, agentes químicos, o sustancias corrosivas de cualquier tipo.
- No someta los equipos a golpes o vibraciones ni intente manipularlos de forma diferente a la indicada en el manual.
- No supere en ningún caso las especificaciones y limitaciones indicadas en el manual.
- Respete en todo momento las condiciones ambientales de trabajo y almacenaje indicadas.
- Durante la instalación y al finalizarla, evite dejar cables sueltos, rotos, desprotegidos o en malas condiciones, pueden suponer un riesgo para el equipo y para sus usuarios.

AKO Electromecànica se reserva el derecho a cualquier modificación tanto en la documentación como en el producto sin previo aviso.

1.- Versiones y referencias

MODELO	DESCRIPCIÓN	ALIMENTACIÓN
AKO-55323	Doble central alarma de hombre encerrado	230 V~ 50/60 Hz
AKO-55123	Central de alarma para 1 cámara	
AKO-55120	Central de alarma para 1 cámara	120 V~ 50/60 Hz
AKO-55326	Pulsador luminoso	-
AKO-58120	Protector para pulsador	-



AKO-55323

AKO-55123
AKO-55120

AKO-55326

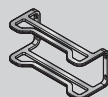

AKO-58120

2.- Advertencias



-La alarma y los pulsadores deben ser instalados en un sitio protegido de las vibraciones, del agua y de los gases corrosivos, donde la temperatura ambiente no supere el valor reflejado en los datos técnicos. La central debe situarse en algún lugar donde se garantice la presencia habitual de personas que puedan alertar de la presencia de alarmas.

-Tanto la alarma como el pulsador no son adecuados para zonas clasificadas como potencialmente explosivas.

3.- Descripción del equipo

Alarma de hombre encerrado para alertar en caso de que una persona quede atrapada en el interior de una cámara frigorífica.

Consta de un pulsador luminoso que debe instalarse en el interior de la cámara frigorífica y de una central de alarma acústica y sonora que debe instalarse en algún lugar donde se garantice la presencia habitual de personas que puedan alertar de la presencia de alarmas.

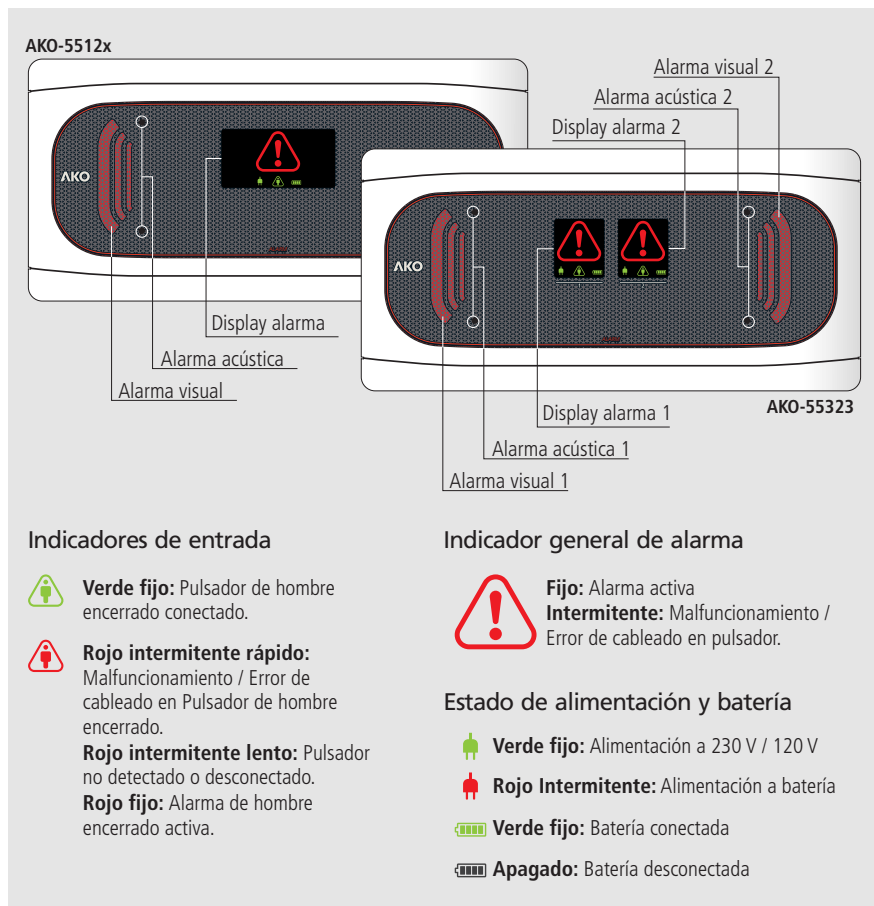

4.- Instalación

- Retirar los embellecedores (1) del equipo.
- Aflojar los tornillos (2) girándolos 1/4 de vuelta y abrir la tapa (3).
- Realizar los taladros para los prensaestopas necesarios para entrada de los cables guiándose por los centros pretrazados de la caja y fijar los prensaestopas en el equipo (4 y 5).
- Realizar los 3 taladros en la pared con ayuda de la plantilla incluida.
- Fijar el equipo a la pared mediante los tornillos y tacos suministrados (6).
- Insertar los cables en los prensaestopas y realizar el conexionado del equipo siguiendo el esquema de la pág. 6.
- **Conectar la batería (7) antes de cerrar la tapa .**
- Cerrar la tapa (3), insertar y apretar los tornillos (2) y volver a poner los embellecedores (1).

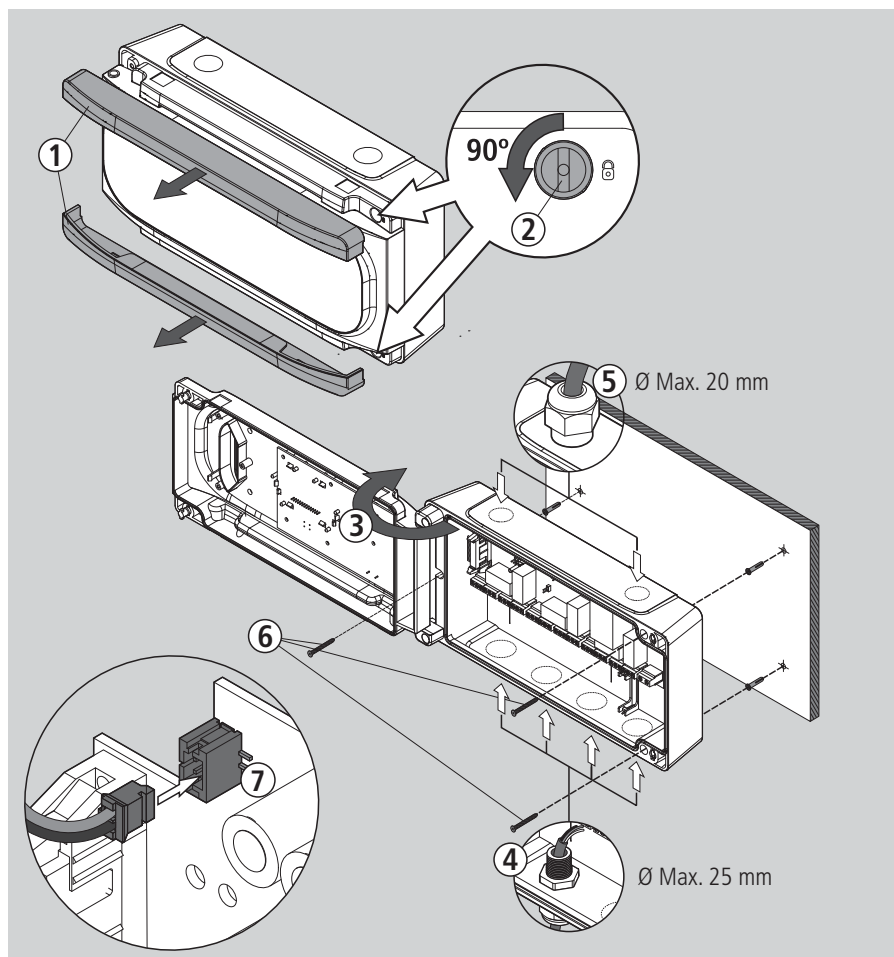

Conexión

El cableado entre el pulsador y la central **NUNCA** debe instalarse en una conducción junto con cables de potencia, control o alimentación.



Desconectar siempre la alimentación para realizar el conexionado.

El circuito de alimentación debe estar provisto de un interruptor para su desconexión de mínimo 2 A, 230 V, situado cerca del aparato. El cable de alimentación será del tipo H05VV-F o NYM-1x16/3.

La sección a utilizar dependerá de la normativa local vigente, pero nunca deberá ser inferior a 1.5 mm². Los cables para el conexionado del contacto del relé, deberán tener la sección adecuada según el equipo a conectar. La zona de conexión a 120 / 230 V~ debe mantenerse despejada de cualquier elemento externo.

Asegurese de haber conectado las baterías antes de la puesta en marcha del equipo.

Según el RD 138/2011 IF12 (ES) y la norma EN-378-1 (EU), la alimentación de la Alarma debe proceder de un circuito diferente al utilizado para el sistema de refrigeración y ventilación.

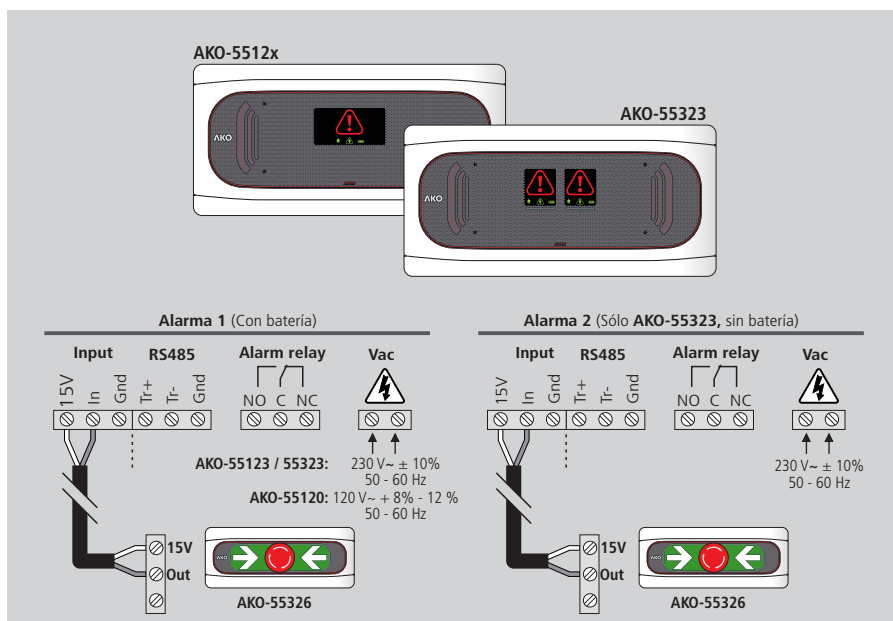

5.- Configuración

Función de autodiagnóstico

El equipo incorpora un sistema de autodiagnóstico que informa al usuario en caso de producirse un mal funcionamiento del detector o pulsador o en caso de errores en el cableado.

En caso de detectar un malfuncionamiento, la alarma emite 3 tonos cortos cada 2 minutos y el indicador de entrada correspondiente se ilumina en rojo de forma intermitente.

6.- Funcionamiento

Sin alarmas













































Los indicadores de entrada se muestran en verde.

Alarma activa

La central emite un tono de alarma acústica, muestra el indicador de la entrada/s afectada/s en rojo, el indicador general de alarma se ilumina y la alarma visual parpadea.

Error de cableado / malfuncionamiento

La central emite 3 tonos cortos cada dos minutos y el indicador de la entrada afectada parpadea en rojo.

		CENTRAL DE ALARMA						
ESTADO								Alarm relay
Sin alarmas activas	Con alimentación Batería conectada						OFF	
	Con alimentación Batería desconectada						OFF	
	Sin alimentación / Con batería						OFF	
	Sin alimentación / Sin batería						OFF	
	-	-	 *			OFF		
	-	-	 *			Sonido bitonal		
Fallo pulsador / cableado	-	-	 *			3 tonos cada 2 minutos		

* Se encenderá el indicador de entrada correspondiente.

7.- Mantenimiento

Limpie la superficie del equipo con un paño suave, agua y jabón.
No utilice detergentes abrasivos, gasolina, alcohol o disolventes.

8.- Conectividad

Las alarmas disponen de un puerto para conexión de datos RS485 (MODBUS), lo cual le permite gestionarlas a distancia mediante un webservice **AKO-5012**.

La dirección MODBUS se establece en fábrica y se indica en la etiqueta de características ubicada en el lateral izquierdo de la alarma. Dicha dirección debe ser diferente para cada equipo dentro de una misma red. La dirección puede modificarse mediante el software **AKONet**. Una vez modificada, la indicada en la etiqueta no tendrá validez.

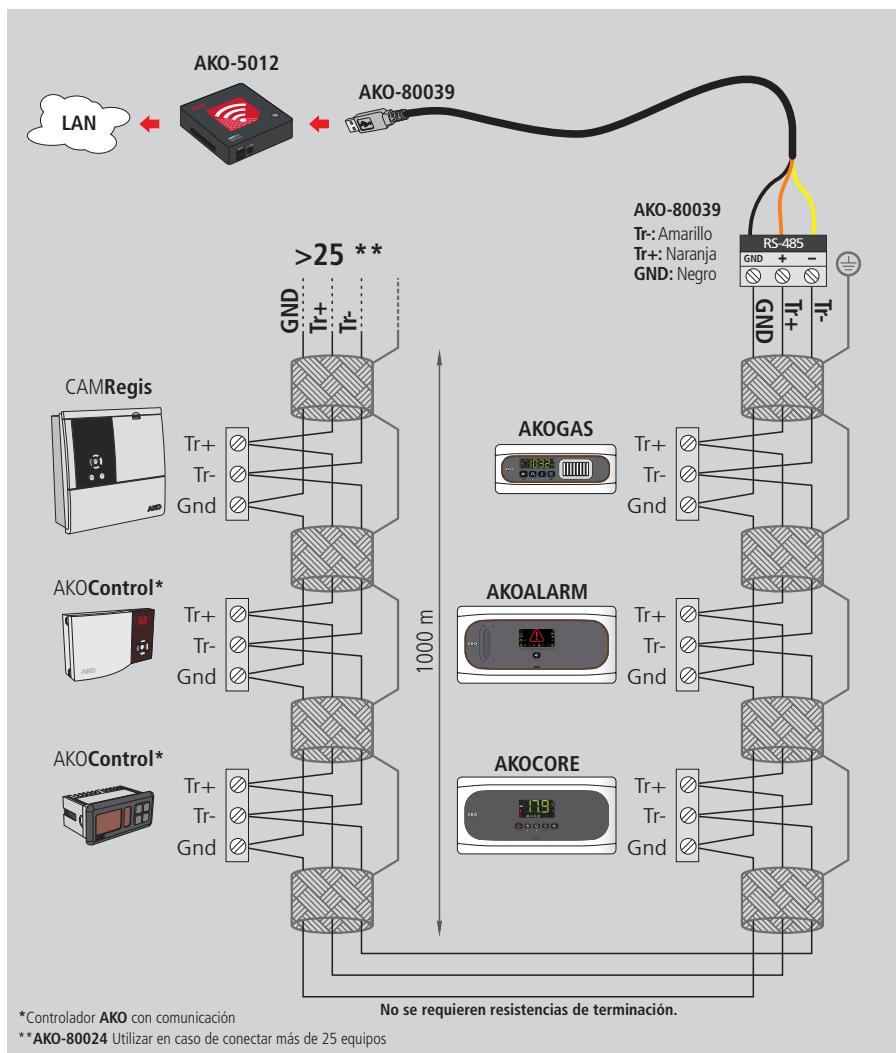

9.- Especificaciones técnicas

Alimentación	AKO-55323 / AKO-55123	230 V~ ± 10% - 50/60 Hz
	AKO-55120	120 V~ + 8% - 12% - 50/60 Hz
Potencia máxima absorbida	AKO-55323 Alarma 1 / Alarma 2	3.1 VA
	AKO-55123	3.1 VA
	AKO-55120	5 VA
Acumuladores		Ni-MH 800 mAh
Autonomía alumbrado + alarma		> 10 Horas (*)
Nº de entradas	AKO-55323 Alarma 1 / Alarma 2	1
	AKO-55123 / AKO-55120	1
Compatibilidad de entradas		Pulsador AKO-55326
Relé alarma		SPDT 230 Vac, 3 A, cos φ = 1
Temperatura ambiente de trabajo		-5 °C a 50 °C
Temperatura ambiente de almacenaje		-30 °C a 70 °C
Grado de protección		IP 65
Categoría de instalación		II s/ EN 61010-1
Grado de polución		II s/ EN 61010-1
Aislamiento doble entre alimentación, circuito secundario y salida relé.		
Potencia sonora		90 dB(A) a 1 metro
Dirección MODBUS		Indicada en la etiqueta
Dimensiones		290 mm (An) x 141 mm (Al) x 84.4 mm (P)
Distancia máxima del cable del pulsador		300 m

10.- Accesorios

Protector AKO-58120

Protege el pulsador frente a posibles golpes

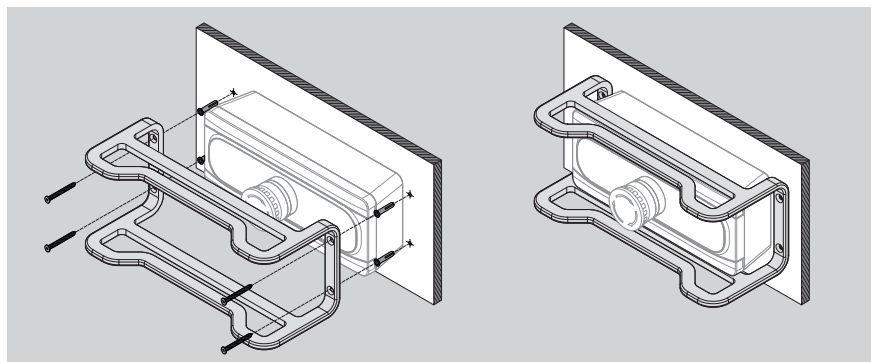

* Duración en estado de alarma a una temperatura de 25 °C.

En **AKO-55323**, solo la alarma 1 dispone de batería.

Index	Page
Versions and references	11
Warnings.....	11
Equipment description	12
Installation	13
Wiring.....	14
Configuration	14
Operation	15
Maintenance	15
Connectivity	16
Technical specifications.....	17
Accessories	17

AKO Electromecànica thanks you and congratulates you on the purchase of our product, the development and manufacture of which involved the most innovative technologies, as well as rigorous production and quality control processes.

Our commitment to achieving customer satisfaction and our continuous efforts to improve day by day are confirmed by the various quality certificates obtained.

This is a high performance, technologically advanced product. Its operation and the final performance achieved will depend, to a great extent, on correct planning, installation, configuration and commissioning. Please read this manual carefully before proceeding to install it and respect the instructions in the manual at all times.

Only qualified personnel may install the product or carry out technical support.

This product has been developed for use in the applications described in the manual. AKO Electromecànica does not guarantee its operation in any use not foreseen in this document and accepts no liability in the case of damage of any type which may result from incorrect use, configuration, installation or commissioning.

Complying with and enforcing the regulations applying to installations where our products are destined to be used is the responsibility of the installer and the customer. AKO Electromecànica accepts no liability for damage which may occur due to failure to comply with these regulations. Rigorously follow the instructions described in this manual.

Whenever a malfunction of the device can cause personal or material damages, the fitter and maintenance staff are responsible for applying the necessary preventive and protection measures to prevent them. In the same way, the correct operation of the device must be periodically checked.

In order to extend the lifetime of our products to the maximum, the following points must be observed:

- Do not expose electronic equipment to dust, dirt, water, rain, moisture, high temperatures, chemical agents or corrosive substances of any type.

- Do not subject equipment to knocks or vibrations or attempt to handle them in any way differently to that indicated in the manual.

- Do not under any circumstances exceed the specifications and limitations indicated in the manual.

- Respect the indicated environmental conditions for operation and storage at all times.

- During installation and on completion of this, avoid the presence of loose, broken or unprotected cables or cables in poor condition. These may constitute a risk for the equipment and its users.

AKO Electromecànica reserves the right to make any modification to the documentation and the product without prior notification.

1.- Versions and references

MODEL	DESCRIPTION	POWER SUPPLY
AKO-55323	Double trapped person station alarm	230 V~ 50/60 Hz
AKO-55123	Station alarm for 1 chamber	
AKO-55120	Station alarm for 1 chamber	120 V~ 50/60 Hz
AKO-55326	Luminous push-button	-
AKO-58120	Protector for push-button	-



AKO-55323

AKO-55123
AKO-55120

AKO-55326

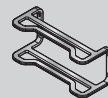

AKO-58120

2.- Warnings



-The alarm and detectors should be installed in a place protected from vibrations, water and corrosive gases, where the ambient temperature does not exceed the value indicated in the technical data. The station should be installed in a place where the regular presence of people who can alert to the presence of alarms is guaranteed.

-Neither the alarm or the push-button are suitable for areas classified as potentially explosive.

3.- Equipment description

Trapped person alarm to raise the alarm in case someone is trapped inside a cold room store.

It is made up of a luminous push-button that must be installed inside the cold room store, and an acoustic and visual alarm centre that must be installed somewhere that guarantees the usual presence of people that can be alerted by the alarm.

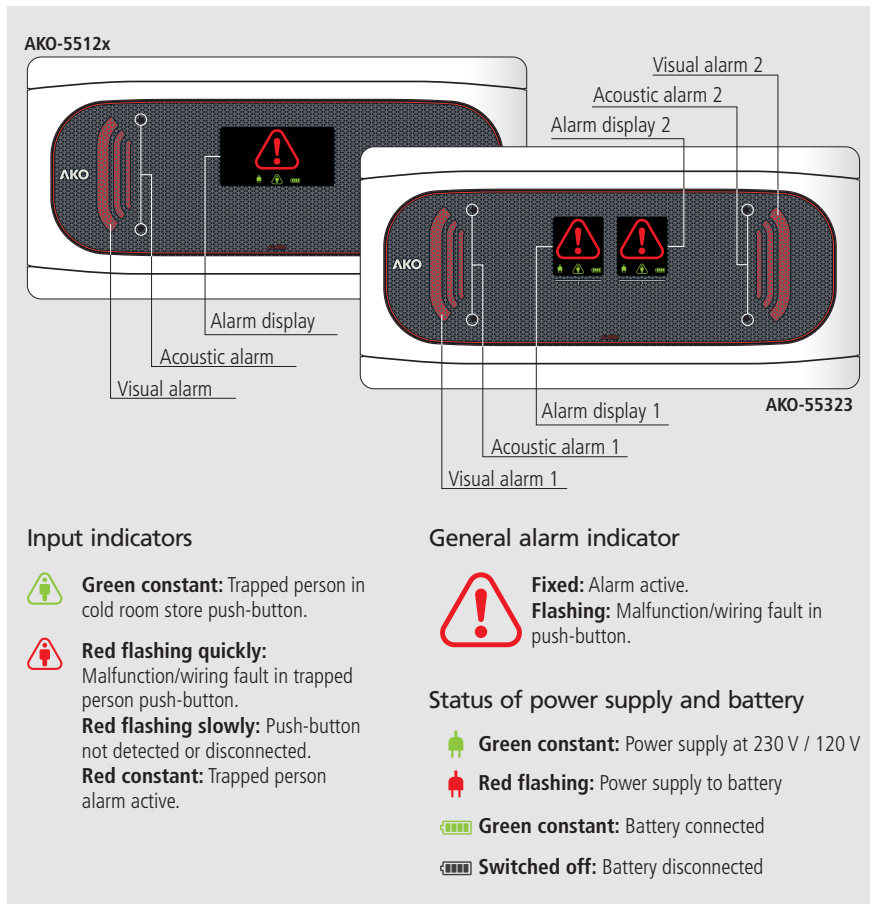

4.- Installation

- Remove the bezels (1) from the unit.
- Loosen the screws (2) by turning them a 1/4 turn and open the cover (3).
- Drill the holes needed for the cable entry glands using the pre-stamped centres on the sides of the housing for guidance. Fix the glands onto the device (4 and 5).
- Make the 3 holes in the wall using template included.
- Fix the unit to the wall using the screws and plugs supplied (6).
- Insert the cables into the glands. Wire the unit following the diagram on page. 14.
- **Connect the battery (7) before closing the cover.**
- Close the cover (3), insert and tighten the screws (2) and replace the bezels (1).

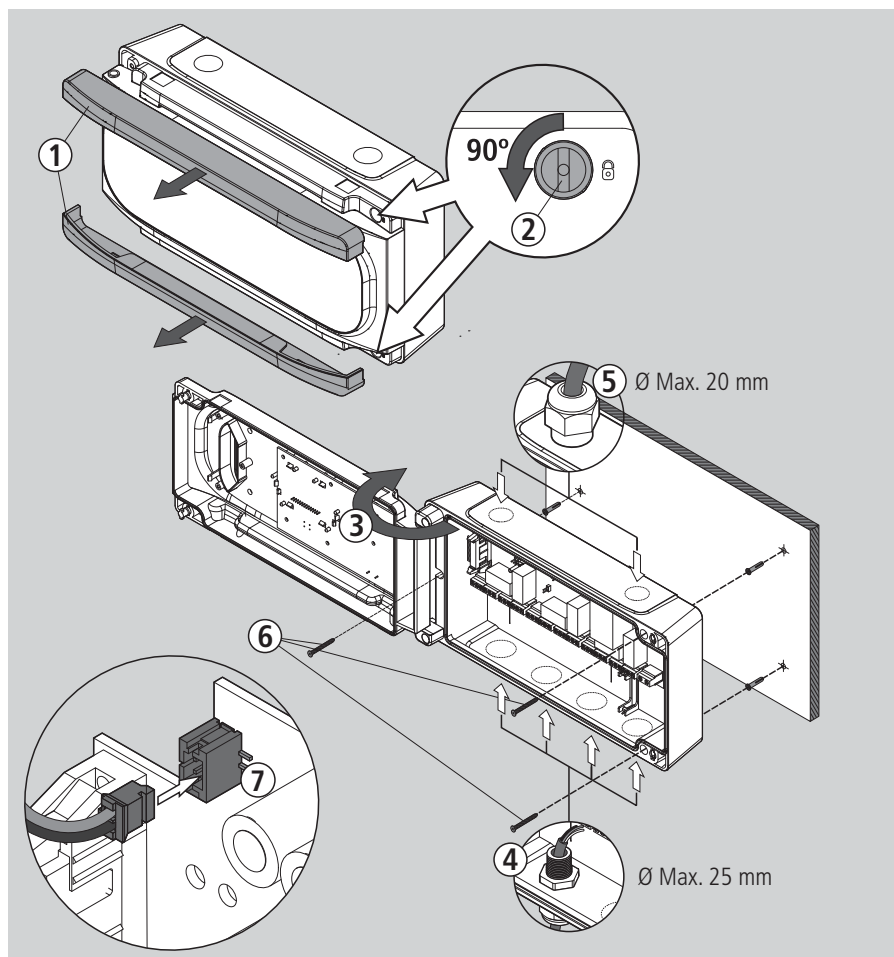

Wiring

The wiring between the detector/button and the station should **NEVER** be installed in a conduit together with power, control or feeder cables.



Always disconnect the power supply to do the wiring.

The power supply circuit should be equipped with a switch for its disconnection of at least 2 A, 230 V, situated near the appliance. The power supply cable will be H05VV-F or NYM-1x16/3. The section to be used will depend on current local regulations, but should never be less than 1.5 mm².

Cables for wiring the relay contact should have an adequate section depending on the unit to be connected.

The 120 / 230 V~ wiring must be kept clear of any other external element.

Make sure you have connected the batteries before starting-up the unit.

Pursuant to **RD 138/2011 IF12** (SP) and standard **EN-378-1** (EU), the Alarm's power supply must come from a different circuit than the one used for the cooling and ventilation system.

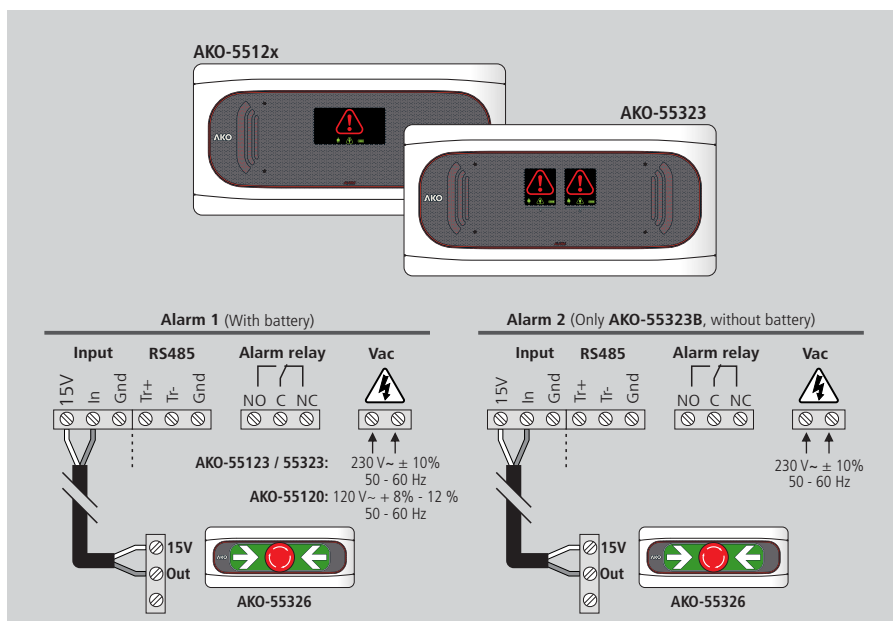

5.- Configuration

Self-diagnosis function

The equipment includes a self-diagnosis system that informs the user in the event of a malfunction in the detector or push-button or if there are errors in the wiring.

If a malfunction is detected, the alarm emits 3 short beeps every 2 minutes and the corresponding input indicator flashes red.

6.- Operation

Without alarms













































The input indicators are green.

Alarm active

The station emits an alarm sound, shows the affected input(s) in red, the general alarm indicator lights up and the visual alarm flashes.

Wiring error/malfunction

The station emits 3 short beeps every two minutes and the input indicator affected flashes red.

STATUS		ALARM STATION						
								Alarm relay
Without active alarms	With power supply Battery connected						OFF	
	With power supply Battery disconnected						OFF	
	Without power supply/ With battery						OFF	
	Without power supply/ Without battery						OFF	
	-	-	 *			OFF		
	-	-	 *			Bitonal sound		
Detector/ wiring fault	-	-	 *			3 short tones every 2 min.		

*The input indicator will turn on.

7.- Maintenance

Clean the surface of the unit with a soft cloth, water and soap.
Do not use abrasive detergents, petrol, alcohol or solvents.

8.- Connectivity

The alarms are equipped with a port for connection of RS485 (MODBUS) data, that allows it to remotely manage them using an **AKO-5012** webserver.

The MODBUS address is set at the factory and is indicated on the rating plate located on the left side of the alarm. This address must be different for each unit within the same network. The address can be changed using the **AKONet** software. Once modified, the old address indicated on the plate will not be valid.

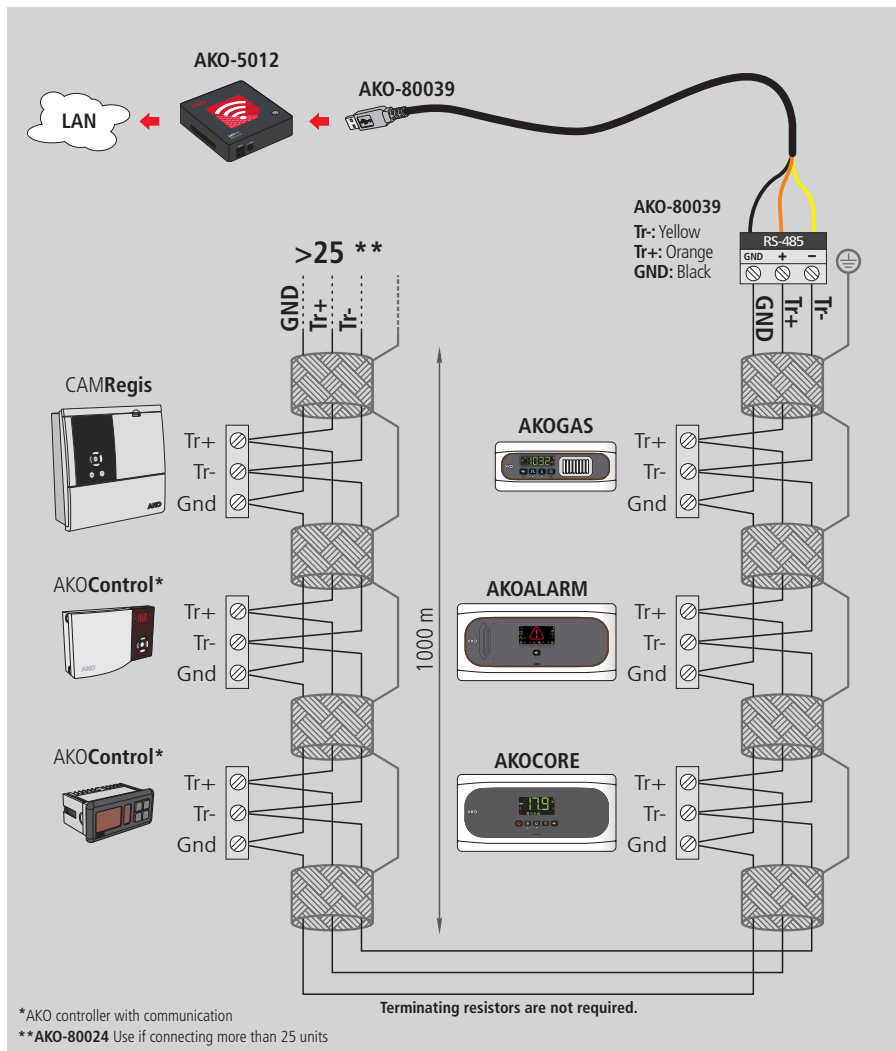

9.- Technical specifications

Power supply	AKO-55323 / AKO-55123	230 V~ ± 10% - 50/60 Hz
	AKO-55120	120 V~ + 8% - 12% - 50/60 Hz
Maximum input power	AKO-55323 Alarm 1 / Alarm 2	3.1 VA
	AKO-55123	3.1 VA
	AKO-55120	5 VA
Accumulators		Ni-MH 800 mAh
Lighting + alarm duration		> 10 hours (*)
No. of inputs	AKO-55323 Alarm 1 / Alarm 2	1
	AKO-55123 / AKO-55120	1
Compatibility of inputs		Button AKO-55326
Alarm relay		SPDT 230 Vac, 3 A, cos φ = 1
Working ambient temperature		-5 °C to 50 °C
Storage ambient temperature		-30 °C to 70 °C
Protection degree		IP 65
Installation category		II s/ EN 61010-1
Pollution degree		II s/ EN 61010-1
Double isolation between power supply, secondary circuit and relay output.		
Sound power		90 dB(A) at 1 metre
MODBUS address		Shown on label
Dimensions		290 mm (W) x 141 mm (H) x 84.4 mm (D)
Maximum distance from push-button wiring		300 m

10.- Accessories

AKO-58120 protector

Protects push-button from possible impacts

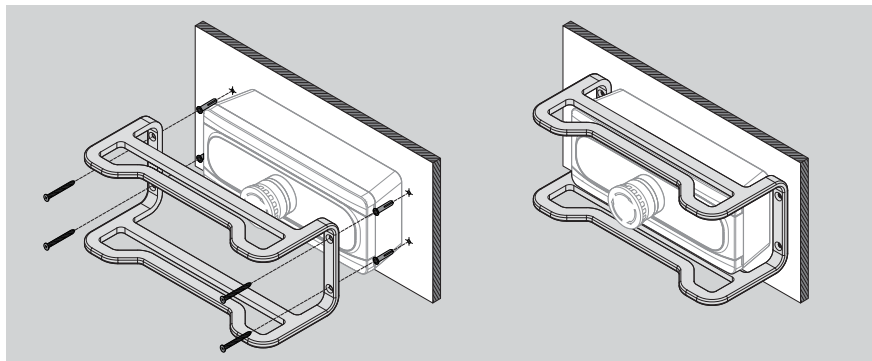

* Duration in alarm status up to a temperature of 25 °C.

In **AKO-55323**, only alarm 1 has a battery.

Index	Pag.
Versions et références.....	19
Avertissements.....	19
Description de l'équipement.....	20
Installation.....	21
Câblage.....	22
Configuration.....	22
Fonctionnement.....	23
Maintenance.....	23
Connectivité.....	24
Spécifications techniques.....	25
Accessoires.....	25

AKO Electromecànica vous félicite et vous remercie d'avoir acheté notre produit qui a été développé et fabriqué à l'aide des technologies les plus innovantes ainsi que des processus de production et de contrôle de la qualité rigoureux.

Notre engagement en faveur de la satisfaction de nos clients et nos efforts continus d'amélioration sont prouvés par les différentes certifications de qualité obtenues.

Ceci est un produit de haute qualité et technologiquement avancé. Son bon fonctionnement ainsi que les prestations finales obtenues dépendront en grande partie d'une planification, installation, configuration et mise en marche correctes. Veuillez lire attentivement ce manuel avant de procéder à l'installation et respectez à tout moment les indications qu'il comporte.

Seul du personnel dûment qualifié est autorisé à installer ou à réaliser l'assistance technique du produit.

Ce produit a été conçu pour être utilisé pour les applications décrites dans son manuel. AKO Electromecànica ne garantit pas son fonctionnement dans les cas non prévus dans ledit document, et ne sera en aucun cas tenue responsable des dommages, quels qu'ils soient, qui pourraient entraîner une utilisation, configuration, installation ou mise en marche incorrectes.

L'installateur et le client doivent respecter et faire respecter les normes applicables aux installations où nos produits sont utilisés. AKO Electromecànica ne sera pas tenue responsable des dommages que pourrait occasionner le non-respect de ces normes. Suivez rigoureusement les indications décrites dans ce manuel.

Si un dysfonctionnement de l'équipement peut provoquer des dommages corporels ou matériels, l'installateur et le personnel de maintenance sont chargés d'appliquer les mesures préventives et de protection nécessaires pour les éviter. Il est également nécessaire de réviser périodiquement le bon fonctionnement de l'équipement.

Afin de prolonger au maximum la durée de vie de nos équipements, respectez les observations suivantes :

Ne pas exposer les équipements électroniques à la poussière, saleté, eau, pluie, humidité, températures élevées, agents chimiques ou substances corrosives de tous types.

Ne pas exposer les équipements à des coups ou des vibrations et ne pas les manipuler d'une façon différente de celle indiquée dans le manuel.

Ne dépasser en aucun cas les spécifications et limitations indiquées dans le manuel.

Respecter à tout moment les conditions environnementales de travail et d'entreposage indiquées.

Lors de l'installation et de sa finalisation, éviter de laisser des câbles lâches, cassés, non protégés ou en mauvais état car ils peuvent présenter un risque pour l'équipement et ses utilisateurs.

AKO Electromecànica se réserve le droit de modifier la documentation et le produit sans préavis.

1.- Versions et références

MODÈLE	DESCRIPTION	ALIMENTATION
AKO-55323	Double centrale d'alarme de personne enfermée	230 V~ 50/60 Hz
AKO-55123	Centrale d'alarme pour 1 caméra	
AKO-55120	Centrale d'alarme pour 1 caméra	120 V~ 50/60 Hz
AKO-55326	Bouton-poussoir lumineux	-
AKO-58120	Protecteurs pour bouton-poussoir	-



AKO-55323

AKO-55123
AKO-55120

AKO-55326

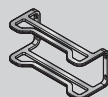

AKO-58120

2.- Avertissements



-L'alarme et les boutons-poussoirs doivent être installés dans un endroit à l'abri des vibrations, de l'eau et des gaz corrosifs, où la température ambiante ne dépasse pas la valeur définie dans les indications techniques. La centrale doit être située en un lieu où sont habituellement présentes des personnes capables de donner l'alerte en cas d'alarme.

-L'alarme et le bouton poussoir ne peuvent pas être utilisés dans des zones classées comme potentiellement explosives.

3.- Description de l'équipement

Alarme de personne enfermée pour alerter si une personne est coincée dans une chambre froide.

Dispose d'un bouton-poussoir lumineux qui être installé dans la chambre froide et d'une centrale d'alarme acoustique et visuelle qui doit être installée dans un lieu où sont habituellement présentes des personnes capables de donner l'alerte en cas d'alarme.

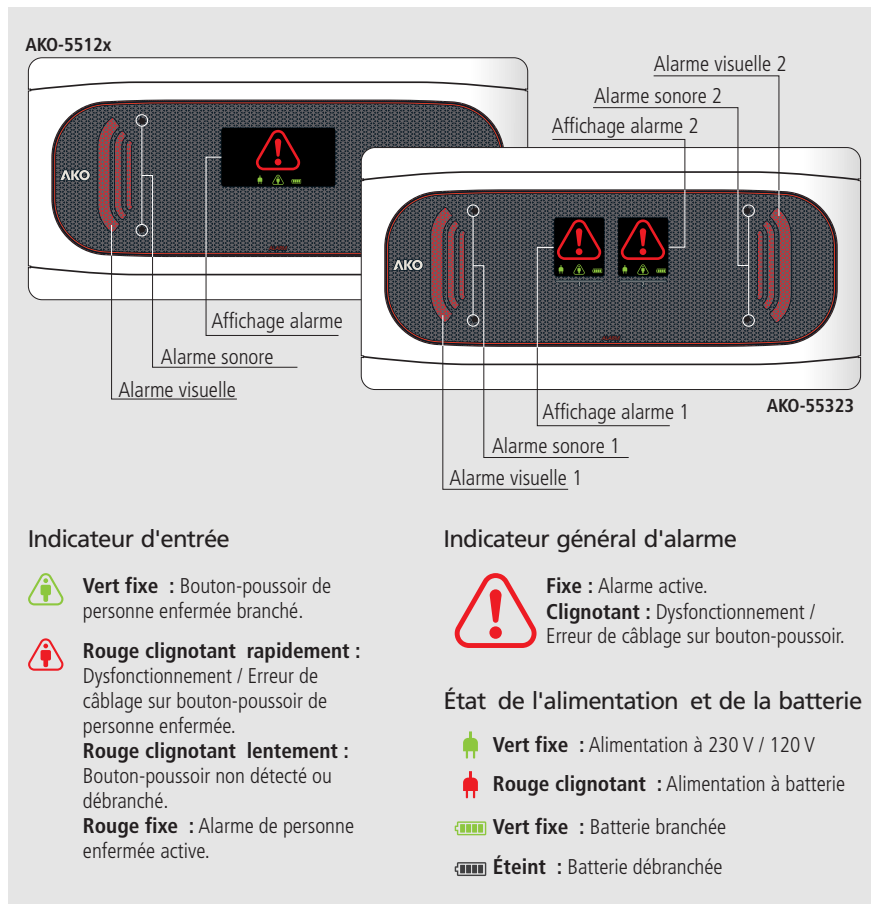

4.- Installation

- Retirez les enjoliveurs (1) de l'appareil.
- Desserrez les vis (2) en les tournant 1/4 de tour et ouvrez le couvercle (3).
- Percez les trous nécessaires pour les presse-étoupes afin d'insérer les câbles en vous guidant grâce aux centres de pré-emboutissage du boîtier et fixez les presse-étoupes sur l'appareil (4 et 5).
- Percez les 3 trous dans le mur à l'aide du gabarit fourni.
- Fixez l'appareil au mur avec les vis et chevilles fournies (6).
- Insérez les câbles dans les presse-étoupes et effectuez les raccordements de l'appareil en suivant le schéma de la page 22.
- **Branchez la batterie (7) avant de refermer le couvercle.**
- Fermez le couvercle (3), introduisez et serrez les vis (2) et remettez les enjoliveurs (1).

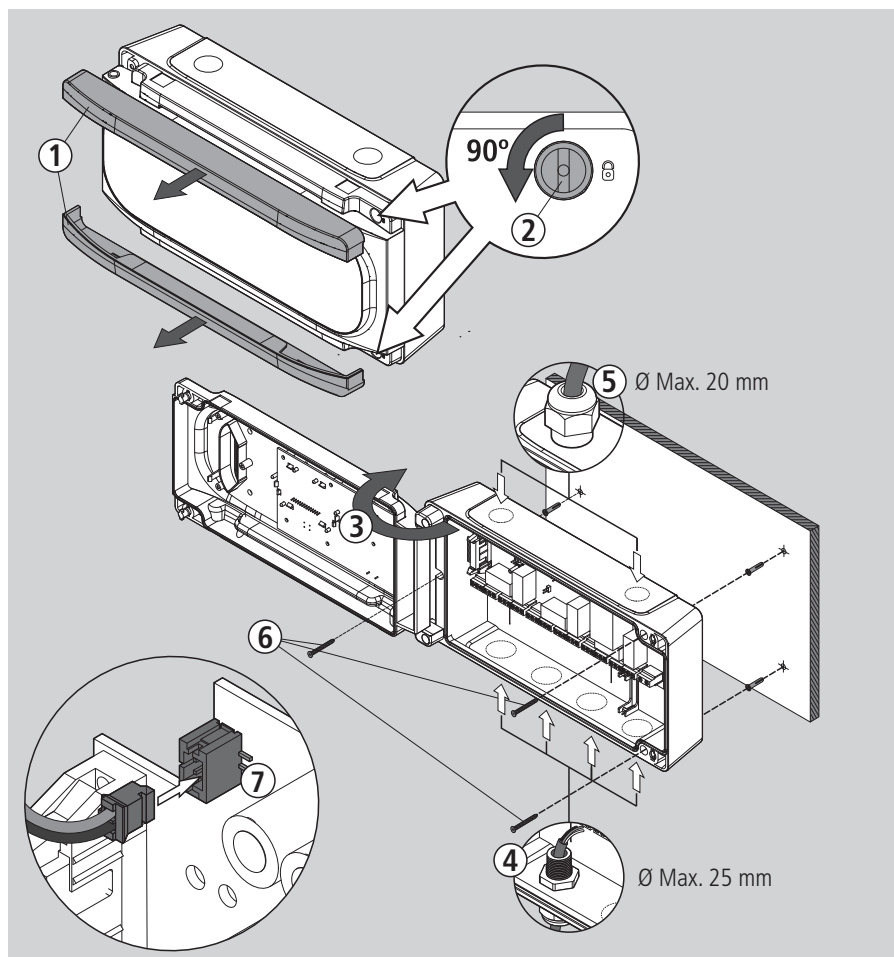

Câblage

Le câblage entre le bouton-poussoir et la centrale **NE DOIT JAMAIS** être installé dans une conduite à côté de câbles électriques, de commande ou d'alimentation.



Coupez systématiquement l'alimentation avant de procéder au câblage.

Le circuit d'alimentation doit être muni d'un interrupteur de déconnexion situé à proximité de l'appareil (2 A, 230 V minimum). Le câble d'alimentation doit être de type H05VV-F ou NYM-1x16/3. La section à utiliser dépend de la réglementation locale en vigueur. Toutefois, elle ne doit jamais être inférieure à 1,5 mm². Les câbles de raccordement du contact du relais doivent posséder une section adaptée à l'appareil à raccorder. La zone de connexion à 120/230 V~ doit être maintenue dégagée de tout élément externe.

Veillez à ce que les batteries soient branchées avant la mise en marche de l'appareil.

Conformément au décret royal **138/2011 IF12** (ES) et à la norme **EN-378-1** (EU), l'alimentation de l'alarme doit provenir d'un circuit distinct de celui qui alimente le système de réfrigération et de ventilation.

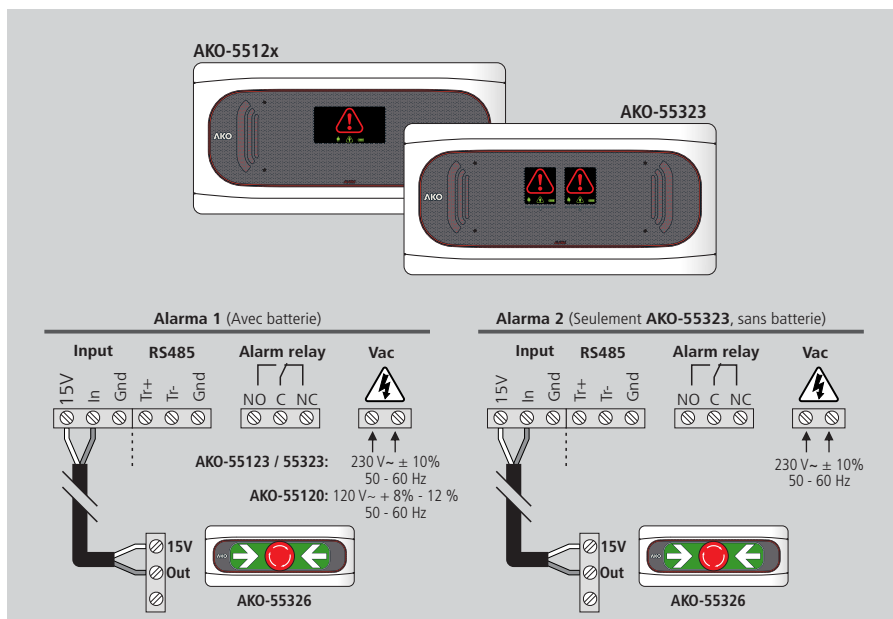

5.- Configuration

Fonction d'autodiagnostic

L'appareil est équipé d'un système d'autodiagnostic qui informe l'utilisateur lorsqu'il y a un dysfonctionnement du détecteur ou du bouton-poussoir ou en cas d'erreurs de câblage.

Lors de la détection d'un dysfonctionnement, l'alarme émet 3 courtes tonalités toutes les 2 minutes et l'indicateur d'entrée correspondant s'allume en rouge et clignote.

6.- Fonctionnement

Sans alarme













































Les indicateurs d'entrée s'affichent en vert.

Alarme active

La centrale émet une tonalité d'alarme sonore, affiche l'indicateur de la ou des entrées concernées en rouge, l'indicateur général d'alarme s'allume et l'alarme visuelle clignote.

Erreur de câblage / dysfonctionnement

La centrale émet 3 courtes tonalités toutes les deux minutes et l'indicateur de l'entrée concernée clignote en rouge.

		CENTRALE D'ALARME						
ÉTAT								Alarm relay
Sans alarme active	Avec alimentation Batterie branchée						OFF	
	Avec alimentation Batterie débranchée						OFF	
	Sans alimentation / Avec batterie						OFF	
	Sans alimentation / Sans batterie						OFF	
	-	-	 *			OFF		
	-	-	 *			Son à deux tonalités		
Défaillance bouton-poussoir / câblage	-	-	 *			3 tonalités toutes les 2 minutes		

* L'indicateur d'entrée correspondant s'allume.

7.- Maintenance

Nettoyez la surface de l'appareil avec un chiffon doux, de l'eau et du savon.
N'utilisez ni détergents abrasifs, ni essence, ni alcool ni dissolvants.

8.- Connectivité

Les alarmes disposent d'un port pour la connexion des données RS485 (MODBUS), qui permet de les gérer à distance au moyen d'un serveur web **AKO-5012**.

L'adresse MODBUS est définie en usine et elle est indiquée sur l'étiquette des caractéristiques située sur le côté gauche de l'alarme. Cette adresse doit être différente pour chaque appareil dans un même réseau. L'adresse peut être modifiée grâce au logiciel **AKONet**. Une fois modifiée, celle indiquée sur l'étiquette ne sera plus valable.

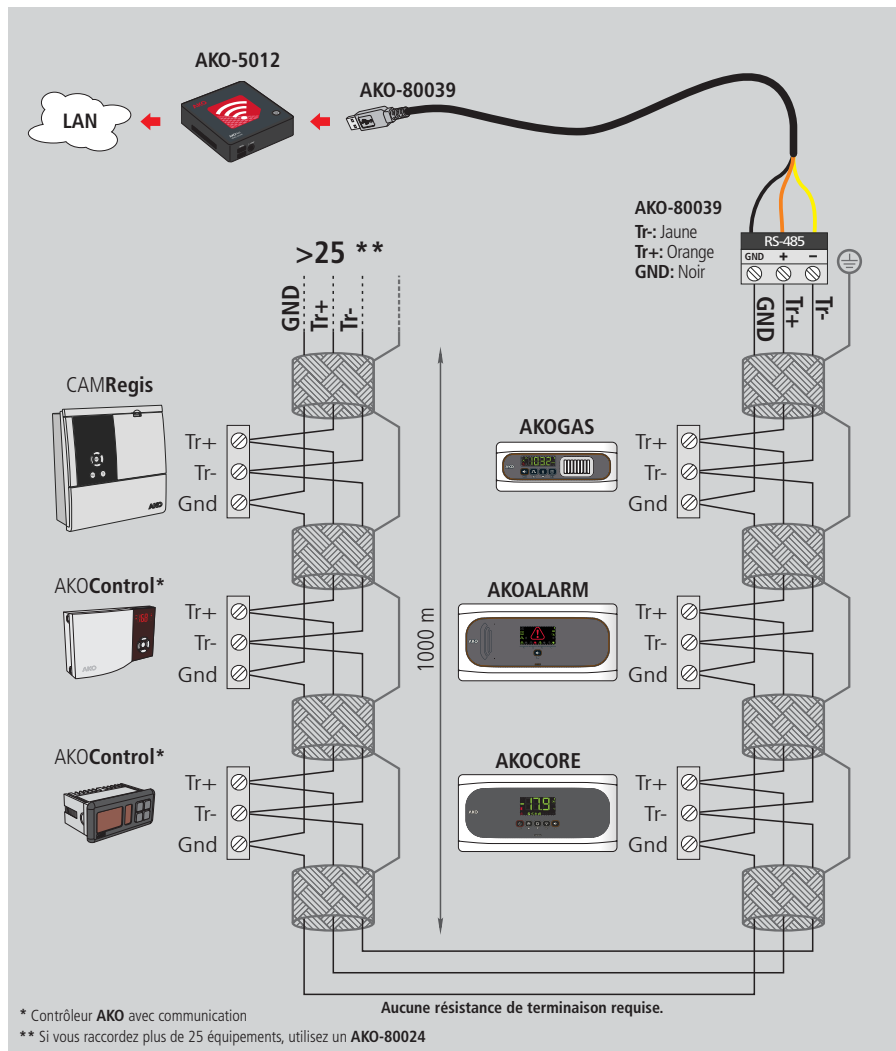

9.- Spécifications techniques

Alimentation	AKO-55323 / AKO-55123	230 V~ ± 10% - 50/60 Hz
	AKO-55120	120 V~ + 8% - 12% - 50/60 Hz
Puissance maximale absorbée	AKO-55323 Alarme 1 / Alarme 2	3.1 VA
	AKO-55123	3.1 VA
	AKO-55120	5 VA
Accumulateurs.....		Ni-MH 800 mAh
Autonomie éclairage + alarme		> 10 heures (*)
Nombre d'entrées	AKO-55323 Alarme 1 / Alarme 2	1
	AKO-55123 / AKO-55120	1
Compatibilité des entrées.....		Bouton-poussoir AKO-55326
Relais alarme		SPDT 230 Vac, 3 A, cos φ = 1
Température ambiante de travail.....		-5 °C à 50 °C
Température ambiante de stockage.....		-30 °C à 70 °C
Degré de protection		IP 65
Catégorie d'installation.....		II s/ EN 61010-1
Degré de pollution		II s/ EN 61010-1
Isolation double entre alimentation, circuit secondaire et sortie relais.		
Puissance acoustique.....		90 dB(A) à 1 mètre
Adresse MODBUS		Indiquée sur l'étiquette
Dimensions.....		290 mm (L) x 141 mm (H) x 84.4 mm (P)
Distance maximale du câble du bouton-poussoir		300 m

10.- Accessoires

Protecteur AKO-58120

Protège le bouton-poussoir contre d'éventuels coups

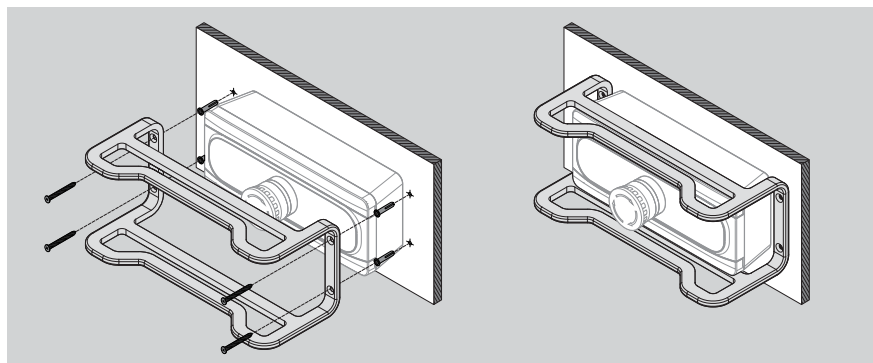

* Durée à l'état d'alarme à une température de 25 °C.

Sur **AKO-55323**, seule l'alarme 1 dispose d'une batterie.

Inhaltsverzeichnis

Seite

Versionen und Art.-Nr.	27
Warnungen	27
Gerätebeschreibung	28
Installation	29
Kabelanschlüsse	30
Konfiguration	30
Betrieb	31
Wartung	31
Kommunikation	32
Technische Daten	33
Zubehör	33

AKO Electromecànica dankt Ihnen und beglückwünscht Sie zum Kauf dieses Produkts. Bei seiner Entwicklung und Herstellung wurden die neuesten Technologien sowie strikte Herstellungsprozesse und Qualitätskontrollen angewendet.

Die verschiedenen Qualitätszertifikate, die wir erhalten haben, stehen für unser Engagement in Bezug auf die Zufriedenheit unserer Kunden und unsere kontinuierlichen Bemühungen, uns tagtäglich zu verbessern.

Dieses Produkt ist hochleistungsstark und technisch fortgeschritten. Seine Funktionsweise hängt in großem Maße von seiner korrekten Planung, Installation, Konfiguration und Inbetriebnahme sowie den erzielten Endleistungen ab. Lesen Sie dieses Handbuch vor der Installation aufmerksam durch und beachten Sie stets die darin beschriebenen Anweisungen.

Das Produkt darf nur von qualifiziertem Personal installiert oder gewartet werden.

Dieses Produkt wurde zur Verwendung in den in diesem Handbuch beschriebenen Anwendungen entwickelt. AKO Electromecànica übernimmt keine Garantie für seine Funktionsweise bei irgendeiner Verwendung, die in dem genannten Dokument nicht vorgesehen ist, sowie keine Haftung für Schäden, die durch eine unsachgemäße Verwendung, Konfiguration, Installation oder Inbetriebnahme verursacht werden.

Es liegt in der Verantwortung des Installateurs und des Kunden, die Rechtsvorschriften, die auf die für unsere Produkte vorgesehenen Installationen anwendbar sind, zu erfüllen und für ihre Erfüllung zu sorgen. AKO Electromecànica übernimmt keinerlei Haftung für Schäden, die aus einer Nichterfüllung der Rechtsvorschriften entstehen können. Folgen Sie strikt den in diesem Handbuch beschriebenen Anweisungen. Immer wenn ein Gerät durch eine Fehlfunktion Verletzungen oder Materialschäden verursacht, ist es die Verantwortung des Installateurs oder Wartungspersonals, diese durch entsprechende Präventions- und Schutzmaßnahmen zu verhindern. Ebenso sollte der korrekte Betrieb des Geräts in regelmäßigen Abständen geprüft werden.

Um die Nutzungsdauer unserer Geräte maximal zu verlängern, sind die folgenden Anweisungen einzuhalten:

Setzen Sie die Geräte keinem Staub, Schmutz, Wasser, Regen, Feuchtigkeit, hohen Temperaturen, Chemikalien oder Ätzmitteln irgendeiner Art aus.

Setzen Sie die Geräte keinerlei Stößen oder Erschütterungen aus und versuchen Sie nicht, sie auf eine andere als in dem Handbuch angegebene Weise zu bedienen.

Überschreiten Sie in keinem Fall die in dem Handbuch angegebenen Spezifikationen und Grenzwerte.

Beachten Sie stets die angegebenen Umgebungsbedingungen in Bezug auf Arbeit und Lagerung.

Hinterlassen Sie während der Installation und bei ihrer Beendigung keine losen, defekten, ungeschützten oder mangelhaften Kabel. Sie können eine Gefahr für das Gerät und seine Benutzer bedeuten.

AKO Electromecànica behält sich das Recht auf Änderungen ohne Vorankündigung sowohl in Bezug auf die Dokumentation als auch das Produkt vor.

1.- Versionen und Art.-Nr.

MODELL	BESCHREIBUNG	STROMVERSORGUNG
AKO-55323	Duogerät mit 100 % Redundanzfunktion	230 V~ 50/60 Hz
AKO-55123	Alarmgerät für 1 Raum	
AKO-55120	Alarmgerät für 1 Raum	120 V~ 50/60 Hz
AKO-55326	Leuchttaster	-
AKO-58120	Tasterschutz	-



AKO-55323

AKO-55123
AKO-55120

AKO-55326

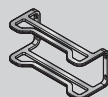

AKO-58120

2.- Warnungen



- Das Alarmgerät und die Taster müssen an einer Stelle installiert werden, wo sie vor Vibrationen, Wasser und ätzenden Gasen geschützt sind, und wo die Umgebungstemperatur den in den technischen Daten angegebenen Wert nicht überschreitet. Das Alarmgerät muss an einer Stelle installiert werden, wo gewährleistet ist, dass sich normalerweise Personen aufhalten, die einen anstehenden Alarm melden können.
- Das Alarmgerät und der Taster sind nicht für explosionsgefährdete Bereiche geeignet.

3.- Gerätebeschreibung

Alarmgerät für eingeschlossene Person das warnt, wenn eine Person im Kühlraum eingeschlossen ist.

Besteht aus einem Leuchttaster, der im Kühlraum installiert wird und über ein Alarmgerät zur Ausgabe eines akustischen und optischen Alarms, das an einem Ort installiert werden muss, an dem gewährleistet ist, dass sich normalerweise Personen aufhalten, die den anstehenden Alarm melden können.

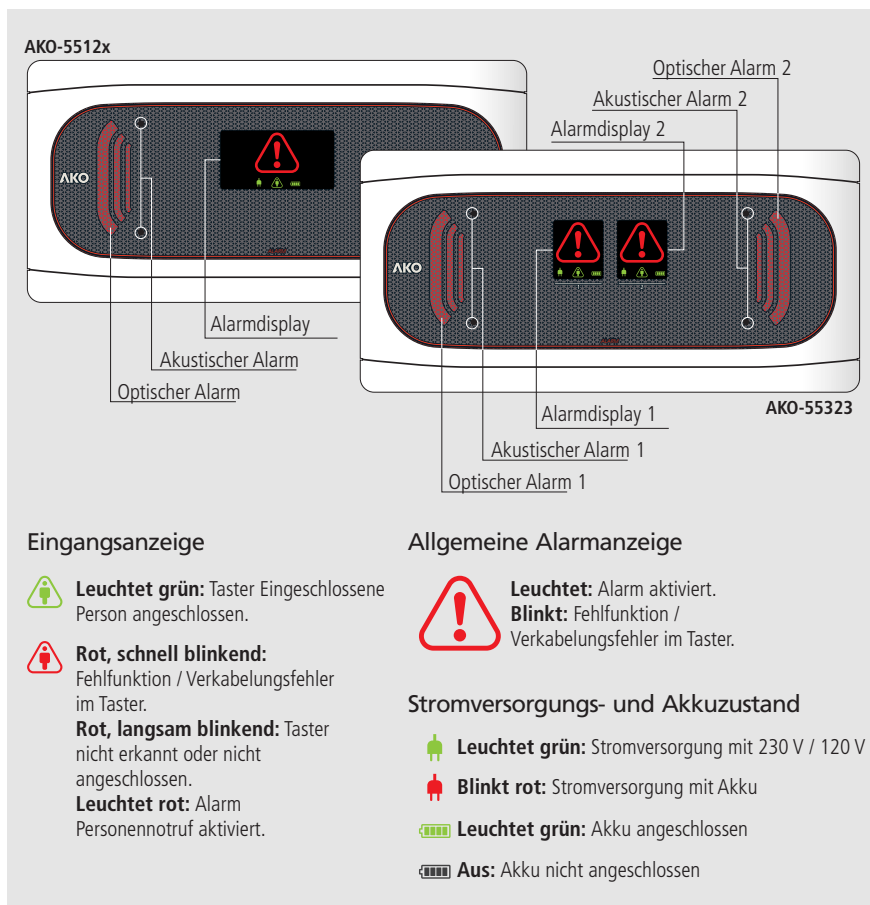

4.- Installation

- Die Zierrahmen (1) vom Gerät entfernen.
- Die Schrauben (2) mit einer 1/4-Umdrehung lösen und den Deckel (3) öffnen.
- Die Bohrungen für die Stopfbuchsen ausführen, die für die Zuleitung der Kabel erforderlich sind; hierzu die vorgestanzt Stellen des Gehäuses verwenden und die Stopfbuchsen am Gerät befestigen (4 und 5).
- Unter Verwendung der mitgelieferten Schablone 3 Bohrlöcher in die Wand bohren.
- Das Gerät mit den mitgelieferten Schrauben und Dübeln (6) an der Wand befestigen.
- Die Kabel in die Stopfbuchsen einführen und das Gerät unter Berücksichtigung des Schemas auf S. 30 verkabeln.
- **Den Akku (7) vor Schließen des Deckels anschließen.**
- Den Deckel (3) schließen, die Schrauben (2) einsetzen und festziehen und die Zierrahmen (1) wieder anbringen.

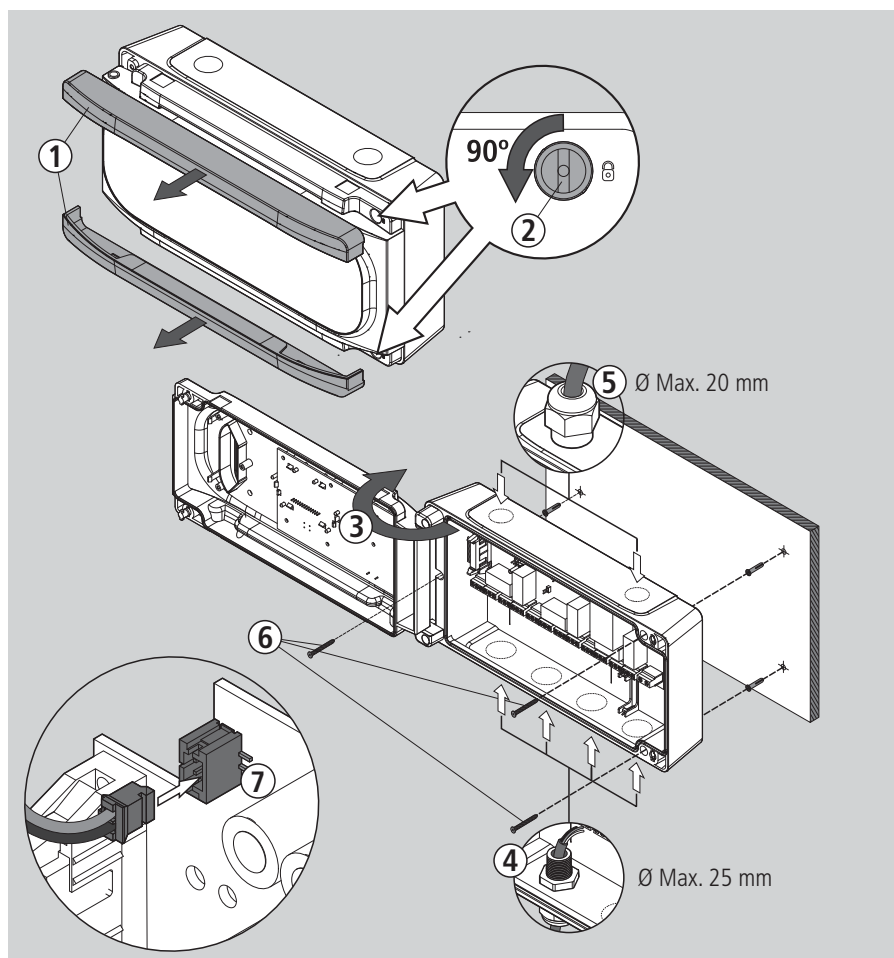

Kabelanschlüsse

Die Kabelanschlüsse zwischen Taster und Alarmgerät dürfen **IN KEINEM FALL** in einem gemeinsamen Kanal mit Leistungs-, Steuer- oder Stromversorgungskabeln verlegt werden.



Vor dem Durchführen der Kabelanschlüsse ist immer die Stromversorgung zu unterbrechen.

Der Stromversorgungskreis muss mit einem in der Nähe des Geräts angebrachten Trennschalter (min. 2 A, 230 V) ausgestattet sein. Das Zuleitungskabel muss vom Typ H05VV-F oder NYM-1x16/3 sein. Der zu verwendende Querschnitt hängt von den örtlich geltenden Vorschriften ab, darf aber nie kleiner als 1,5 mm² sein. Die Kabel für den Anschluss des Relaiskontakts müssen den für das anzuschließende Gerät geeigneten Querschnitt aufweisen.

Der Bereich für den Anschluss an 120 / 230 V~ muss stets frei von externen Elementen sein.

Vor der Inbetriebnahme des Geräts sicherstellen, dass die Akkus angeschlossen sind.

Gemäß Königlichem Erlass **RD 138/2011 IF12** (ES) und der Norm **EN-378-1** (EU) muss die Stromversorgung des Alarmgerätes über einen anderen Schaltkreis erfolgen, als den, der für das Kühl- und Lüftungssystem vorgesehen ist.

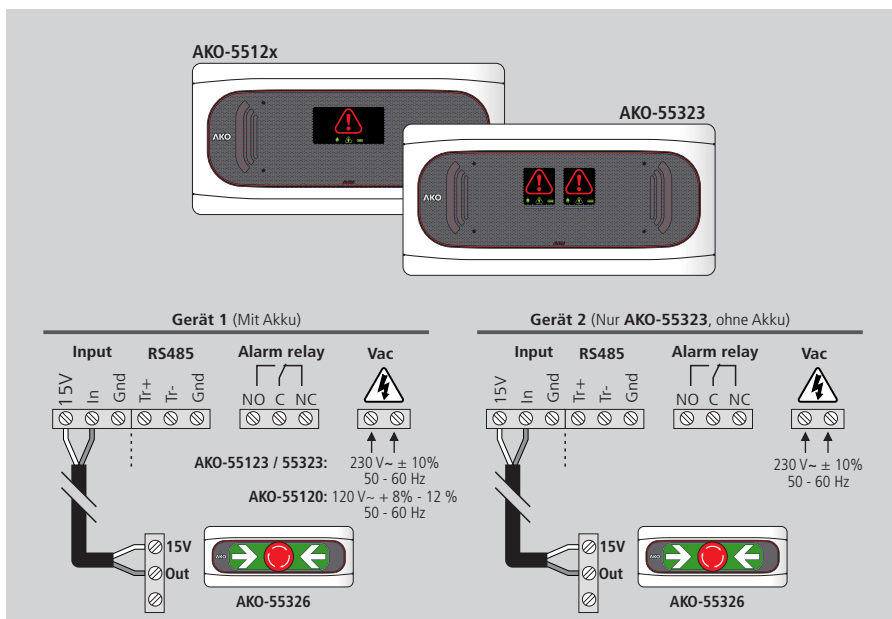

5.- Konfiguration

Eigendiagnosefunktion

Das Gerät verfügt über eine Eigendiagnose, die den Benutzer über Fehlfunktionen des Sensors bzw. des Tasters oder bei Verkabelungsfehlern in Kenntnis setzt.

Bei Erfassen einer Fehlfunktion gibt das Alarmgerät alle 2 Minuten 3 kurze Signaltöne aus und die Anzeige des betreffenden Eingangs blinkt rot.

6.- Betrieb

Kein Alarm













































Die Eingangsanzeigen leuchten grün.

Bei aktiviertem Alarm

Das Alarmgerät gibt ein akustisches Alarmsignal aus, die Anzeige des betroffenen Eingangs/der betroffenen Eingänge leuchtet rot, die allgemeine Alarmanzeige leuchtet auf und der optische Alarm blinkt.

Verkabelungsfehler / Fehlfunktion

Das Alarmgerät gibt alle zwei Minuten 3 kurze Signaltöne aus und die Anzeige des betroffenen Eingangs blinkt rot.

		ALARMGERÄT						
ZUSTAND								Alarm relay
Ohne aktivierte Alarme	Mit Stromversorgung Akku angeschlossen						OFF	
	Mit Stromversorgung Akku nicht angeschlossen						OFF	
	Ohne Stromversorgung / Mit Akku						OFF	
	Ohne Stromversorgung / Ohne Akku						OFF	
	-	-	 *			OFF		
	-	-	 *			Zweiton- Signal		
Fehler Taster / Verkabelung	-	-	 *			3 Signaltöne alle 2 Minuten		

* Die Anzeige des betreffenden Eingangs leuchtet auf.

7.- Wartung

Die Oberfläche des Geräts mit einem weichen Tuch, Wasser und Seife reinigen.

Keine scheuernden Reinigungsmittel, Benzin, Alkohol oder Lösungsmittel verwenden.

8.- Konnektivität

Die Alarmgeräte verfügen über einen RS485-Datenanschluss (MODBUS), womit die Daten mittels eines PCs mit dem Webserver **AKO-5012** fernverwaltet werden können.

Die MODBUS-Adresse wird werkseitig eingestellt und ist auf dem Typenschild angegeben, das an der linken Seite des Alarmgeräts angebracht ist. Diese Adresse muss für jedes Gerät in ein und demselben Netz eindeutig sein. Die Adresse kann mit Hilfe der Software **AKONet** (auf dem Webserver installiert) geändert werden. Bei einer Änderung der Adresse verliert die auf dem Typenschild angegebene Adresse ihre Gültigkeit.

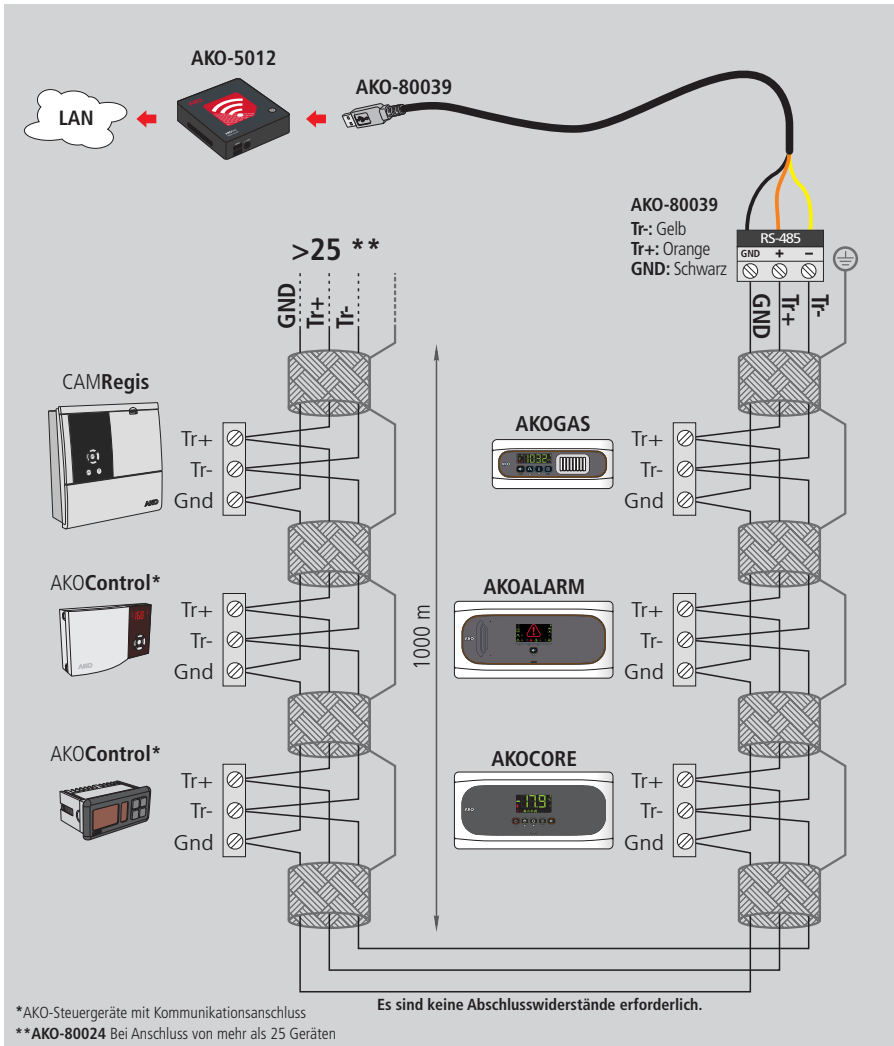

9.- Technische Daten

Stromversorgung	AKO-55323 / AKO-55123	230 V~ ± 10% - 50/60 Hz
	AKO-55120	120 V~ + 8% - 12% - 50/60 Hz
Max. Leistungsaufnahme	AKO-55323 Alarm 1 / Alarm 2	3.1 VA
	AKO-55123	3.1 VA
	AKO-55120	5 VA
Speicher		Ni-MH 800 mAh
Autonomie Beleuchtung + Alarm		> 10 Stunden (*)
Anz. Eingänge	AKO-55323 Alarm 1 / Alarm 2	1
	AKO-55123 / AKO-55120	1
Kompatibilität der Eingänge		Taster AKO-55326
Alarm-Relais		SPDT 230 Vac, 3 A, cos φ = 1
Arbeitstemperaturbereich		-5 °C bis 50 °C
Lagerumgebungstemperatur.....		-30 °C bis 70 °C
Schutzgrad		IP 65
Installationsklasse.....		II s/ EN 61010-1
Verschmutzungsgrad.....		II s/ EN 61010-1
Doppelte Isolierung zwischen Stromversorgung, Sekundärschaltkreis und Relaisausgang.		
Schallleistung.....		90 dB(A) in 1 Meter Abstand
MODBUS-Adresse.....		Auf dem Typenschild angegeben
Abmessungen.....		290 mm (B) x 141 mm (H) x 84.4 mm (T)
Max. Abstand des Tasterkabels.....		300 m

10.- Zubehör

Schutz AKO-58120

Schützt den Taster vor Stoßeinwirkungen

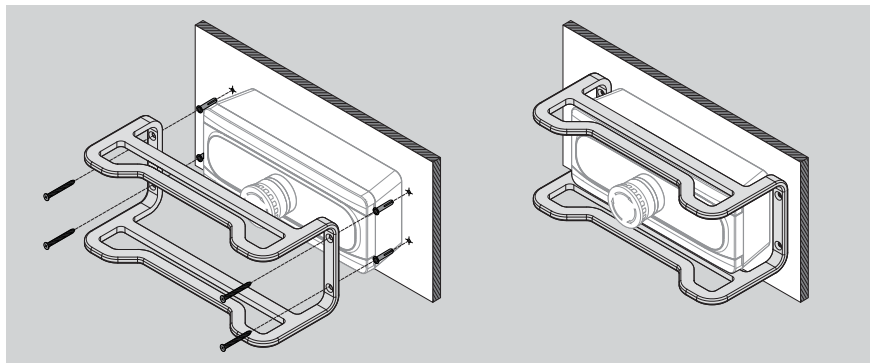

* Dauer des Alarmstatus bei einer Temperatur von 25 °C.
Bei **AKO-55323** verfügt nur das Alarmgerät 1 über einen Akku.

Índice	Pág.
Versões e referências	35
Advertências	35
Descrição do equipamento.....	36
Instalação	37
Ligações	38
Configuração.....	38
Funcionamento	39
Manutenção.....	39
Conectividade	40
Especificações técnicas	41
Acessórios.....	41

A AKO Electromecânica agradece o seu interesse e felicita-o pela aquisição do nosso produto, em cujo desenvolvimento e fabrico foram aplicadas as tecnologias mais inovadoras, assim como rigorosos processos de produção e controlo da qualidade.

O nosso compromisso com a satisfação dos nossos clientes e o esforço constante de melhoria diária estão patentes nas várias certificações de qualidade obtidas.

Este é um produto de elevado rendimento e tecnologicamente avançado. O seu correcto planeamento, instalação, configuração e arranque determinarão em grande parte o seu funcionamento, assim como o seu desempenho final. Leia atentamente este manual antes de iniciar a instalação e respeite constantemente as indicações deste.

Apenas podem instalar ou proceder à assistência técnica do produto pessoal devidamente qualificado.

Este produto foi desenvolvido para utilização com as aplicações descritas no respectivo manual, a AKO Electromecânica não garante o seu funcionamento em caso de utilização não prevista no referido documento, assim como não se responsabilizará em caso algum por danos de qualquer tipo eventualmente provocados por uma utilização, configuração, instalação ou arranque incorrectas.

É da responsabilidade do instalador cumprir e fazer cumprir as regras aplicáveis às instalações onde serão instalados os nossos produtos. A AKO Electromecânica não assumirá qualquer responsabilidade pelos danos eventualmente ocasionados pelo incumprimento das referidas regras. Respeite rigorosamente as instruções descritas neste manual.

Sempre que uma avaria do equipamento possa provocar danos físicos ou materiais, é da responsabilidade do instalador e do pessoal da manutenção aplicar as medidas preventivas e de protecção necessárias para os evitar. Do mesmo modo, deve-se proceder a revisões periódicas do correcto funcionamento do equipamento.

A fim de prolongar ao máximo a vida dos nossos equipamentos devem ser respeitadas as seguintes observações:

Não exponha os equipamentos electrónicos ao pó, sujidade, água, chuva, humidade, temperaturas elevadas, agentes químicos ou substâncias corrosivas de tipo algum.

Não submeta os equipamentos a embates ou vibrações nem tente manuseá-los de forma diferente da indicada no manual.

Em caso algum deve superar as especificações e limitações indicadas no manual.

Respeite sempre as condições ambientais de trabalho e de armazenagem indicadas.

Durante a instalação e conclusão da mesma evite deixar cabos soltos, partidos, desprotegidos ou em más condições, podem constituir um perigo para o equipamento e utilizadores deste.

A AKO Electromecânica reserva-se o direito de introduzir qualquer modificação tanto na documentação como no produto sem aviso prévio.

1.- Versões e referências

MODELO	DESCRIÇÃO	ALIMENTAÇÃO
AKO-55323	Central dupla de alarme de homem fechado	230 V~ 50/60 Hz
AKO-55123	Central de alarme para 1 câmara	
AKO-55120	Central de alarme para 1 câmara	120 V~ 50/60 Hz
AKO-55326	Botão luminoso	-
AKO-58120	Protetor para botão	-



AKO-55323

AKO-55123
AKO-55120

AKO-55326

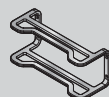

AKO-58120

2.- Advertências



-O alarme e os detectores devem ser instalados num local protegido das vibrações, da água e dos gases corrosivos, onde a temperatura ambiente não ultrapasse o valor indicado nos dados técnicos. A central deve situar-se num local de presença habitual garantida de pessoas que possam alertar para a presença de um sinal de alarme.

-Tanto o alarme como o botão não sejam adequados para zonas classificadas como potencialmente explosivas.

3.- Descrição do equipamento

Alarme de homem fechado para alertar caso uma pessoa fique presa no interior de uma câmara frigorífica.

Composto por um botão luminoso que deve ser instalado no interior da câmara frigorífica e por uma central de alarme acústico e visual que deve ser instalado num local onde seja garantida a presença habitual de pessoas que possam alertar para a presença de alarmes.

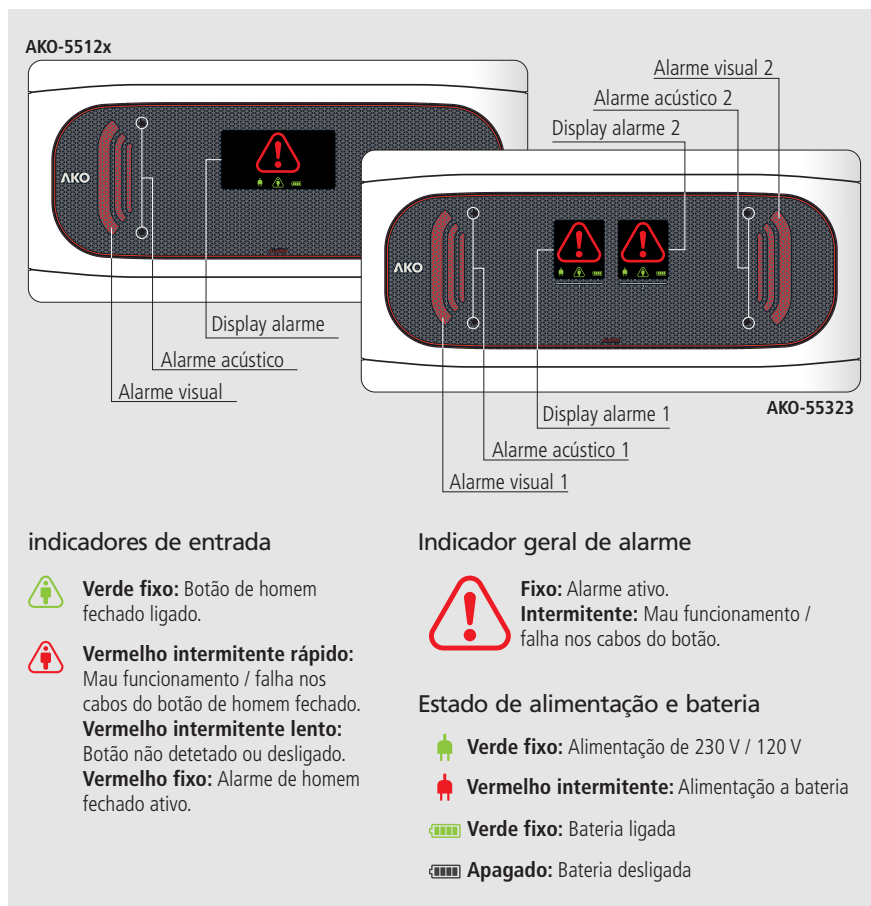

4.- Instalação

- Retirar os frisos (1) do equipamento.
- Desapertar os parafusos (2) rodando-os 1/4 de volta e abrir a tampa (3).
- Efetuar as furações para os prensa-estopas necessários para entrada dos cabos segundo as marcações pré-estampadas da caixa e fixar os prensa-estopas no equipamento (4 e 5).
- Efetuar as 3 furações na parede com auxílio do esquema incluído.
- Fixar o equipamento à parede usando os parafusos e as buchas fornecidas (6).
- Inserir os cabos nos prensa-estopas e ligar o equipamento seguindo o esquema da pág. 38.
- **Ligar a bateria (7) antes de fechar a tampa.**
- Fechar a tampa (3), inserir e apertar os parafusos (2) e voltar a colocar os frisos (1).

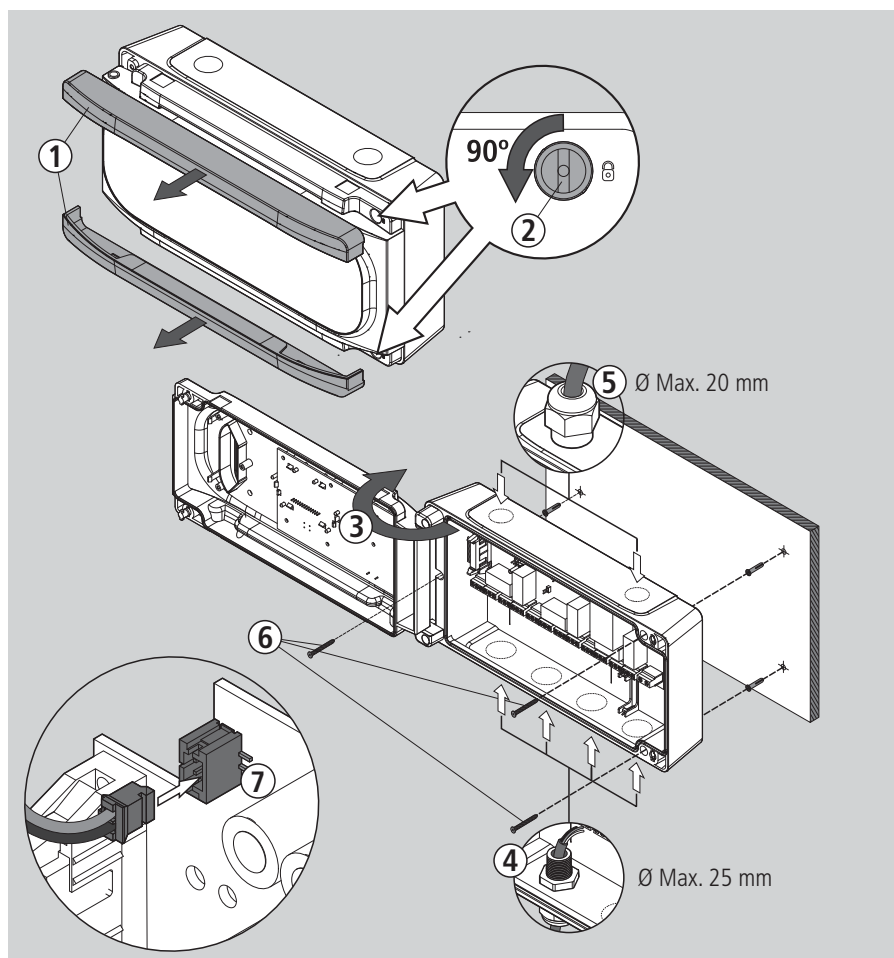

Ligações

Os cabos entre o botão e a central **NUNCA** devem ser instalados num sistema de condução junto dos cabos de potência, controlo ou alimentação.



Desligar sempre a alimentação para efetuar as ligações.

O circuito de alimentação deve estar equipado com um interruptor para se desligar com o mínimo de 2 A, 230 V, situado próximo do aparelho. O cabo de alimentação será do tipo H05VV-F ou NYM-1x16/3.

A secção a utilizar dependerá dos regulamentos locais em vigor, mas nunca deverá ser inferior a 1.5 mm².

Os cabos para as ligações do contacto do relé deverão possuir a secção adequada conforme o equipamento que se pretende ligar.

A zona de ligação de 120 / 230 V~ deve manter-se desprovida de qualquer elemento externo.

Verificar se as baterias estão ligadas antes da colocação em funcionamento do equipamento.

Segundo o RD (decreto real) **138/2011 IF12** (ES) e a norma **EN-378-1** (UE), a alimentação do alarme deve ter origem num circuito diferente do utilizado para o sistema de refrigeração e ventilação.

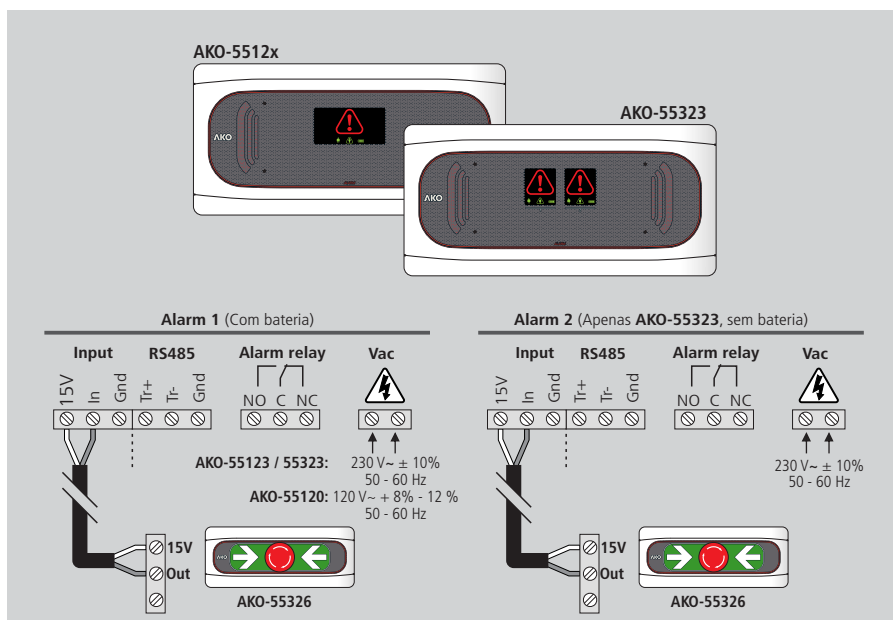

5.- Configuração

Função de auto-diagnóstico

O equipamento incorpora um sistema de autodiagnóstico que informa o utilizador caso ocorra um mau funcionamento do detetor ou do botão ou em caso de falha dos cabos.

Caso detete um mau funcionamento, o alarme emite 3 sinais curtos a cada 2 minutos e o indicador de entrada correspondente acende a vermelho de forma intermitente.

6.- Funcionamento

Sem alarmes













































Os indicadores de entrada são apresentados a verde.

Alarme ativo

A central emite um aviso de alarme acústico, mostra o indicador da(s) entrada(s) afetada(s) a vermelho, o indicador geral de alarme acende e o alarme visual pisca.

Falha dos cabos / mau funcionamento

A central emite 3 avisos sonoros curtos a cada dois minutos e o indicador da entrada afetada pisca a vermelho.

		CENTRAL DE ALARME						
ESTADO								Alarm relay
Sem alarmes ativos	Com alimentação Bateria ligada						OFF	
	Com alimentação Bateria desligada						OFF	
	Sem alimentação / Com bateria						OFF	
	Sem alimentação / Sem bateria						OFF	
	-	-	 *			OFF		
	-	-	 *			Aviso sonoro duplo		
Falha do botão / cabos	-	-	 *			3 sinais a cada 2 minutos		

* Acender-se-á o indicador de entrada correspondente.

7.- Manutenção

Limpar a superfície do equipamento com um pano macio, água e sabão.
Não utilizar detergentes abrasivos, gasolina, álcool ou solventes.

8.- Conectividade

Os alarmes dispõem de uma porta para ligação de dados RS485 (MODBUS) que permitem geri-los à distância através de um servidor **AKO-5012**.

A direção MODBUS é definida de fábrica e é indicada na etiqueta de características colocada na lateral esquerda do alarme. A referida direção deve ser diferente para cada equipamento dentro de uma mesma rede. A direção pode ser alterada através do software **AKONet**. Uma vez modificada, a indicação da etiqueta perde a validade.

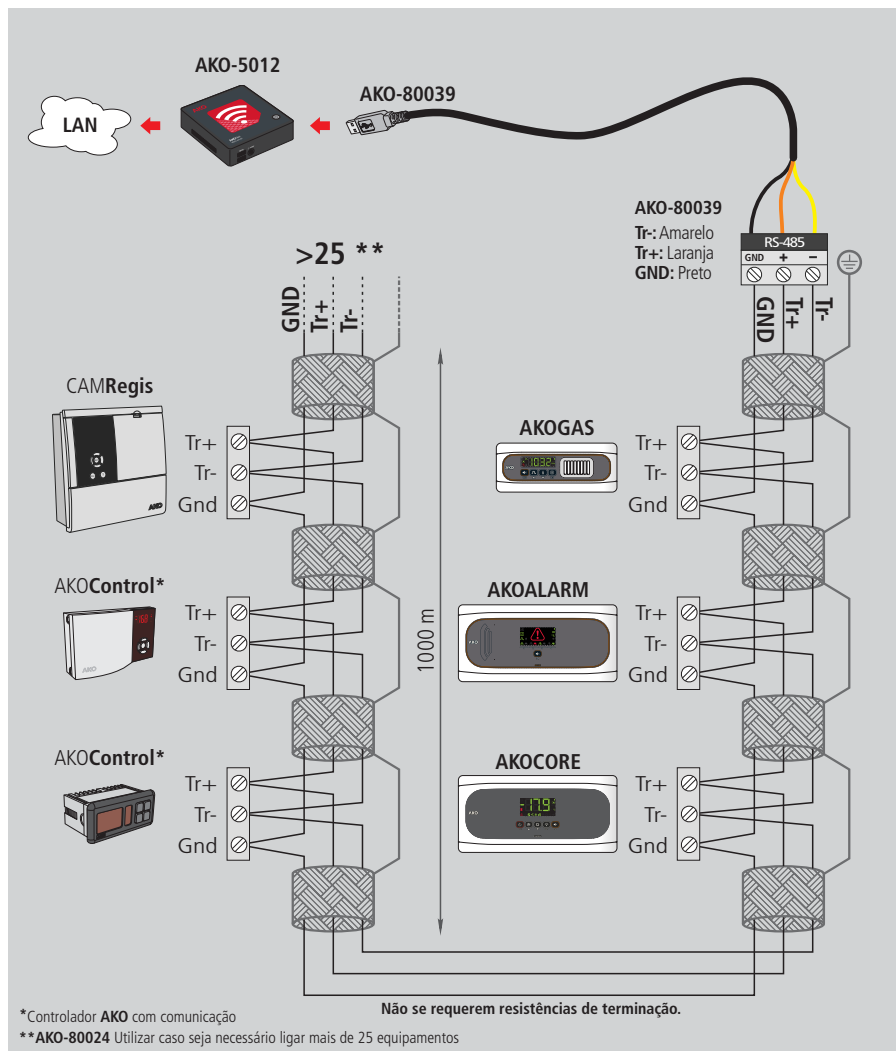

9.- Especificações técnicas

Alimentação	AKO-55323 / AKO-55123	230 V~ ± 10% - 50/60 Hz
	AKO-55120	120 V~ + 8% - 12% - 50/60 Hz
Potência máxima absorvida	AKO-55323 Alarm 1 / Alarm 2	3.1 VA
	AKO-55123	3.1 VA
	AKO-55120	5 VA
Acumuladores		Ni-MH 800 mAh
Autonomia iluminação + alarme.....		> 10 Horas (*)
Nº de entradas	AKO-55323 Alarm 1 / Alarm 2	1
	AKO-55123 / AKO-55120	1
Compatibilidade de entradas.....		Botão AKO-55326
Relé alarme		SPDT 230 Vac, 3 A, cos φ = 1
Temperatura ambiente de trabalho		-5 °C a 50 °C
Temperatura ambiente de armazenamento.....		-30 °C a 70 °C
Grau de proteção.....		IP 65
Categoria de instalação		II s/ EN 61010-1
Grau de poluição		II s/ EN 61010-1
Duplo isolamento entre a alimentação, circuito secundário e output do relé.		
Potência sonora.....		90 dB(A) a 1 metro
Direção MODBUS		Indicada na etiqueta
Dimensões.....		290 mm (L) x 141 mm (A) x 84.4 mm (P)
Distância máxima do cabo do botão.....		300 m

10.- Acessórios

Protetor AKO-58120

Protege o botão de possíveis golpes

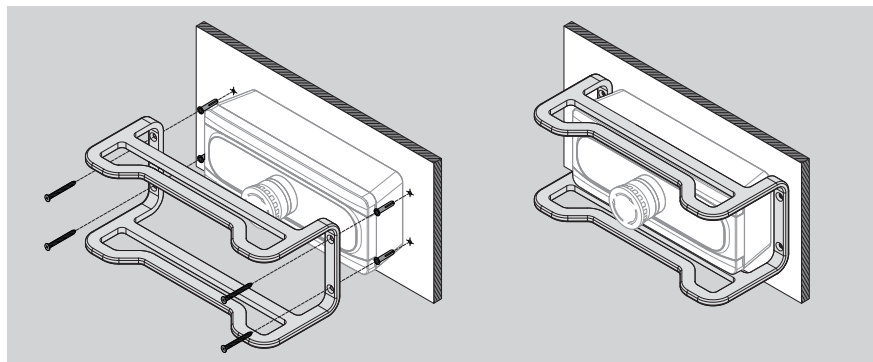

* Duração em estado de alarme com uma temperatura de 25 °C.
No **AKO-55323**, apenas o alarme 1 dispõe de bateria.

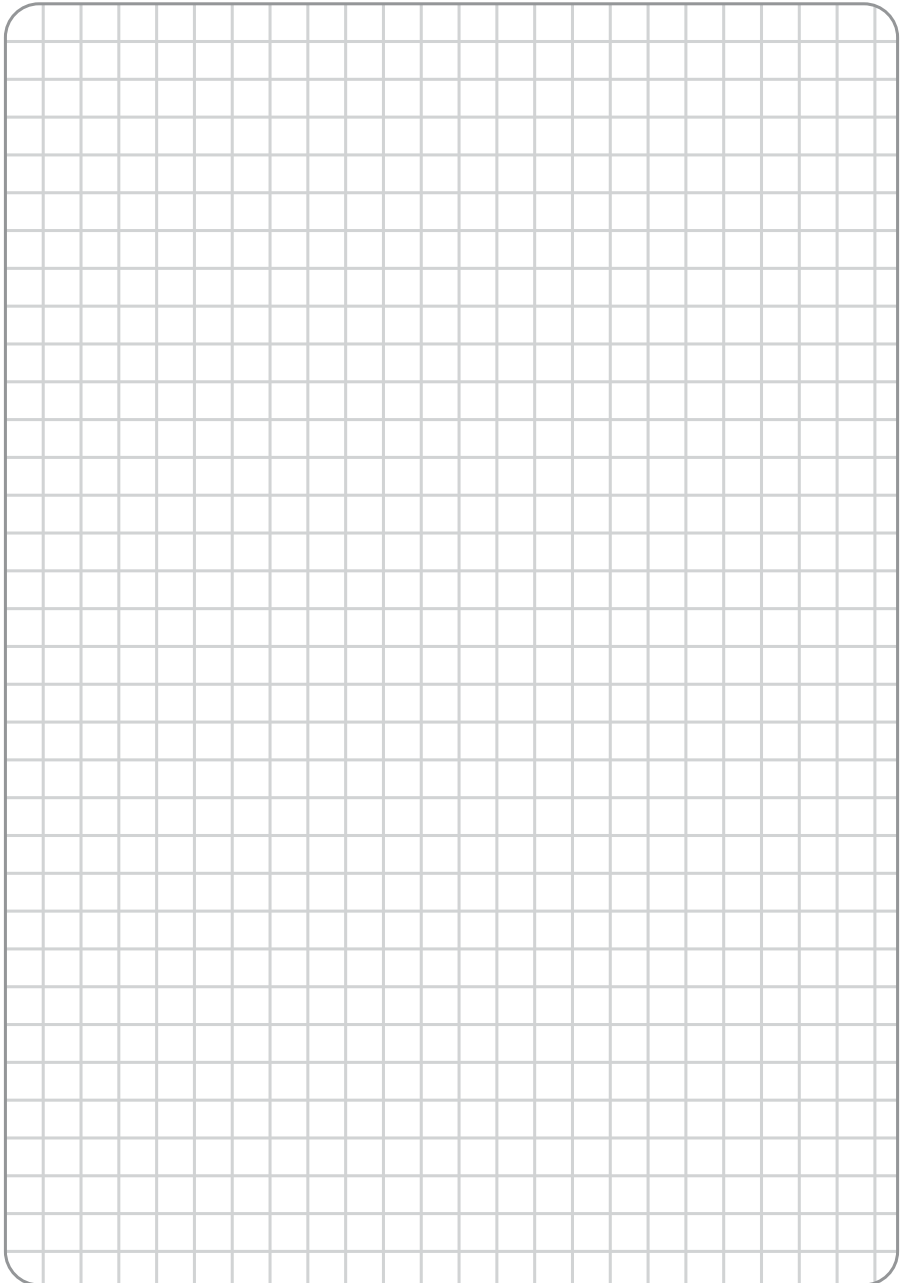

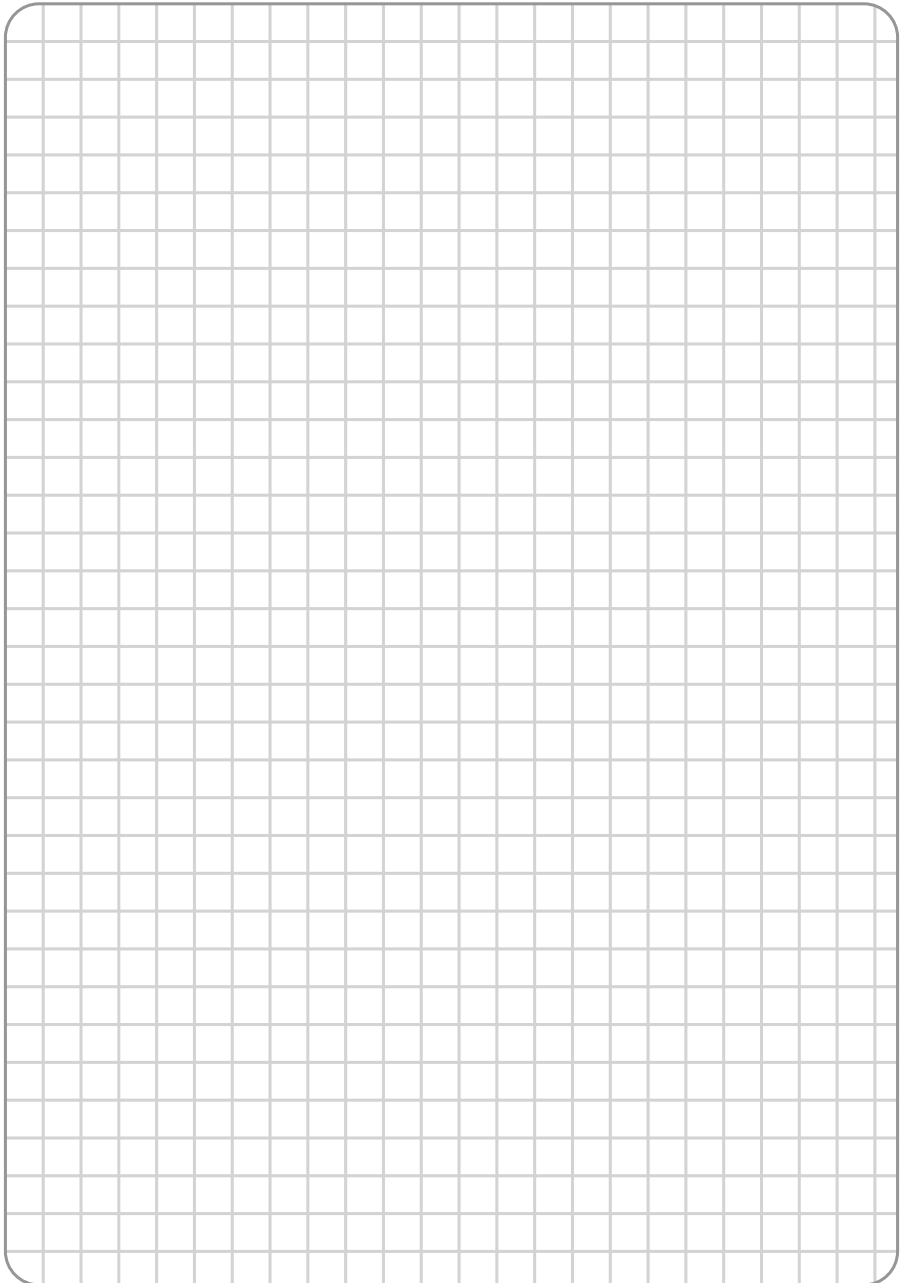

AKO ELECTROMECAÁNICA , S.A.L.

Avda. Roquetes, 30-38

08812 • Sant Pere de Ribes.

Barcelona • Spain.

www.ako.com

355532301 REV/02 2023

Nos reservamos el derecho de suministrar materiales que pudieran diferir levemente de los descritos en nuestras Hojas Técnicas. Información actualizada en nuestra web.
We reserve the right to supply materials that might vary slightly to those described in our Technical Sheets. Updated information is available on our website.
Nous nous réservons le droit de fournir des produits qui peuvent légèrement différer de ceux décrits dans nos Fiches techniques. Informations actualisées sur notre site Web.
Geringfügige Änderungen der Materialien gegenüber den Beschreibungen in den technischen Datenblättern vorbehalten. Aktualisierte Informationen finden Sie auf unserer Website.
Reservamo-nos o direito de fornecer materiais que podem divergir ligeiramente dos materiais descritos nas nossas Fichas técnicas. Informações atualizadas no nosso website