

User Guide

Interface EKC 366



The controller is used for regulating a valve in a refrigerating system - for example in connection with:

- Long-term storage of fruits and vegetables
- Refrigerating plant
- Brewery systems
- Processing plant

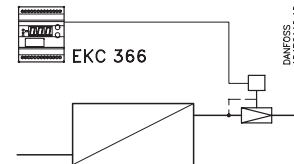

Application

Here the controller has been specially designed for the following functions:

Maintenance of a constant evaporating pressure

A temperature sensor in the valve's actuator will regulate its temperature. This temperature is an indication of the pressure in the valve, and the interface module will keep this temperature constant.

The media temperature is regulated by a PLC or similar device

Here the interface module receives a variable signal from the PLC and will subsequently regulate the valve, so that the refrigeration will be as accurate as possible.

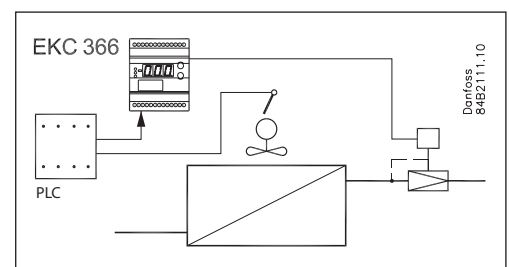

System

The controller must always be used in conjunction with a pilot valve of the types shown here.

The most commonly used one is pilot valve CVQ in conjunction with main valve PM3 (sketched out above).

Valve types:

- CVQ + PM
- KVQ
- TQ
- PHTQ
- TEAQ
- CVMQ



Function

The valve constantly receives feedback of the pressure in the evaporator. Whatever the variations in the suction pressure from the compressor, this feedback will produce the result that the evaporating pressure is kept constant.

In conjunction with the controller, an electronic constant-pressure valve is thus obtained.

Inserted between the controller and the actuator is a so-called inner regulating loop. This loop will - via an NTC resistance - constantly control the temperature in the actuator.

In an application where a PLC or similar device is used for regulating a media temperature, the regulating system will in this way be supplied with an outer regulating loop - which will result in great regulating accuracy.

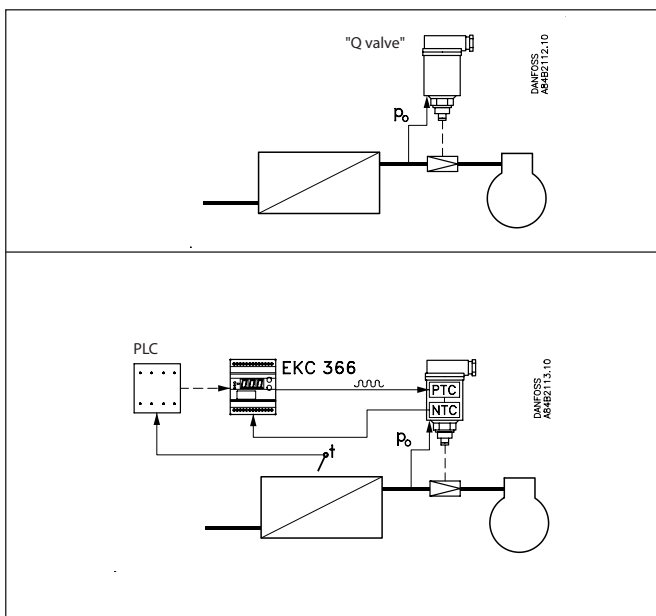

Survey of functions

Function	Parameter	Parameter by operation via data communication
Temperature regulation		Actuator temperature
Display of valve temperature The display constantly shows the valve's temperature. The display is filtered over a period of approx. 10 seconds	-	Actuator temp.
Valve's basic temperature reference This temperature setting is the valve's basic setting. At this value no signal must be received from an external regulation. The setting value is taken from one of the curves shown and may be fine-adjusted later when the valve has reached the temperature (read the manometer in the system). (Push both buttons simultaneously to set the menu)	-	SP Temp.
Temperature unit Set here whether the controller is to show the temperature values in °C or in °F. If indication in °F is selected, other temperature settings will also change over to Fahrenheit, either as absolute values or as delta values.	r05	Temp. unit (°C=0, °F=1) (In AKM only °C is displayed, whatever the setting).
Input signal's temperature influence This setting determines how much the input signal has to raise the temperature in the valve. You should aim at selecting the value, so that the valve can close at the highest occurring evaporating pressure when the input signal is maximum (value to be set in Kelvin)	r06	Ext.Ref.offset K
Reference The valve's temperature is regulated on the basis of the basic setting plus the signal from the external regulation. (Reference = SP Temp + percentage of "r06") The reference can be seen when you push the lower of the two buttons	-	Actuator Ref.
Sundry configurations		Miscellaneous
External signal Here you set the signal that is to be connected to the controller. 0: no signal 1: 4-20 mA 2: 0-20 mA 3: 0-10 V 4: 2-10 V	o10	AI Type
Frequency Set network frequency	o12	50 / 60 Hz (50=0, 60=1)
Data communication If the controller is built into a network with data communication, it must have an address, and the master gateway of the data communication must then know this address. These settings can only be made when a data communication module has been mounted in the controller and the installation of the data communication cable has been completed. This installation is mentioned in a separate document "RC.8A.C".		Following installation of a data communication module, the controller can be operated on a par with the other controllers in ADAP-KOOL® refrigeration controls.
The address is set between 1 and 60	o03	
The address is sent to the gateway when the menu is set in pos. ON	o04	
Language This setting is only required when data communication is connected to the controller. Settings: 0=English, 1=German, 2=French, 3=Danish, 4=Spanish, and 6= Swedish When the controller is operated via data communication, the texts in the right-hand column will be shown in the selected language. When you change the setting to an other language you must activate o04 before "the new language" can be visible from the AKM program.	o11	Language
Service		
The signal will be constantly updated. If you wish to follow the signal beyond the 20 seconds, the time-out period, push one of the two buttons before the time-out period expires		
External current signal Here you can read the value of the current signal received by the controller at its input	u06	AI mA
External voltage signal Here you can read the value of the voltage signal received by the controller at its input	u07	AI Volt

Operation

Display

The values will be shown with three digits, and with a setting you can determine whether they are to be shown in °C or in °F.

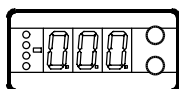

LED's on the front panel

There is one LED on the front panel which will light up when power is sent to the pilot valve.

There are furthermore three LED's which will flash if there is an error in the regulation. In this situation you can show the error code on the display and cut out the alarm by giving the upper button a brief push.

The controller can give the following messages:	
E1	Errors in the controller
E11	Valve's actuator temperature outside its range
E12	Input signal outside its range

The buttons

When you want to change a setting, the two buttons will give you a higher or lower value depending on the button you are pushing. But before you change the value, you must have access to the menu. You obtain this by pushing the upper button for a couple of seconds - you will then enter the column with parameter codes. Find the parameter code you want to change and push the two buttons simultaneously. When you have changed the value, save the new value by once more pushing the two buttons simultaneously.

- Gives access to the menu
- Gives access to changes
- Saves a change

Examples of operations

Set the valve's basic temperature reference

1. Push the two buttons simultaneously
2. Push one of the buttons and select the new value
3. Push both buttons again to conclude the setting

Read the valve's regulating reference

1. Push the lower button
(After approx. 20 seconds the controller automatically returns to its setting, and it again shows the valve's actual temperature)

Set one of the other menus

1. Push the upper button until a parameter is shown
2. Push one of the buttons and find the parameter you want to change
3. Push both buttons simultaneously until the parameter value is shown
4. Push one of the buttons and select the new value
5. Push both buttons again to conclude the setting

Menu survey

SW =1.2x

Function	Parameter	Min.	Max.
Read valve's actual temperature (standard display)	-		°C
Set valve's basic temperature reference	-	40.0°C	140°C
Read valve's regulation reference	-		°C
Select temperature unit (°C/°F)	r05	°C	°F
Input signal's temperature influence	r06	-99.9 K	99.9 K
Controller's address	o03*	1	60
ON/OFF switch (service-pin message)	o04*	-	-
Define input signal 0: no signal 1: 4 - 20 mA 2: 0 - 20 mA 3: 0 - 10 V 4: 2 - 10 V	o10	0	4
Language (0=English, 1=German, 2=french, 3=Danish, 4=Spanish, 6=Swedish). When you change this setting you must also activate o04.	011*	0	6
Set supply voltage frequency	o12	50 Hz	60 Hz
Service information			
Read value of external current signal	u06		mA
Read value of external voltage signal	u07		V

*) This setting will only be possible if a data communication module has been installed in the controller.

Factory setting

If you need to return to the factory-set values, it can be done in this way:

- Cut out the supply voltage to the controller
- Keep both buttons depressed at the same time as you reconnect the supply voltage

Valve's working temperature

Without external signal

The working temperature must be set on the basis of one of the following curves. Find the actuator temperature corresponding to the required evaporating temperature (push). Set the value in the controller as mentioned under "Set the valve's basic temperature reference".

With external signal

If the valve is to be operated with an external signal, two settings have to be made. One is as mentioned to the left, and the other determines how much the signal must be able to raise the temperature in the valve. This value is also read on one of the following curves.

Set the value in the r06 menu.

If the set value is too low, the valve will not be able to close/open fully.

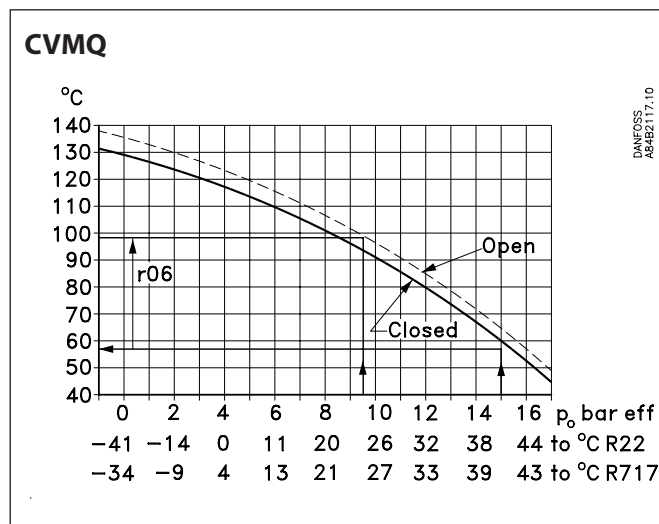
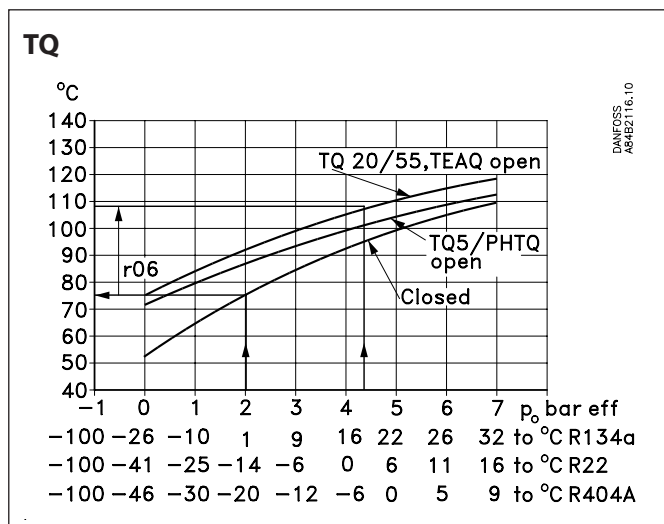
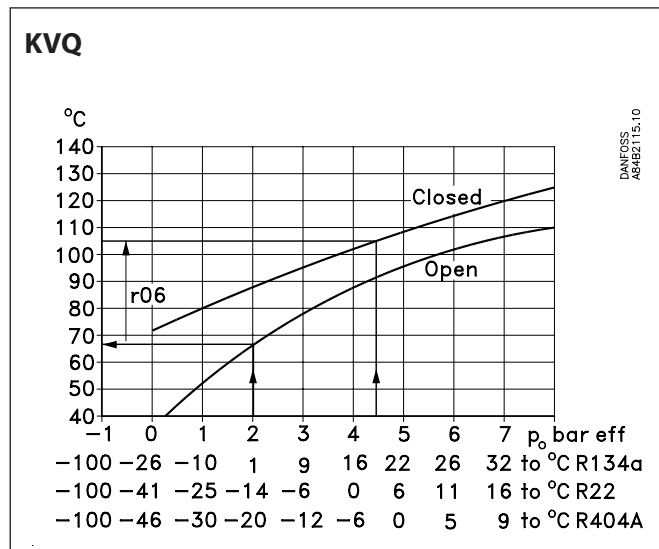
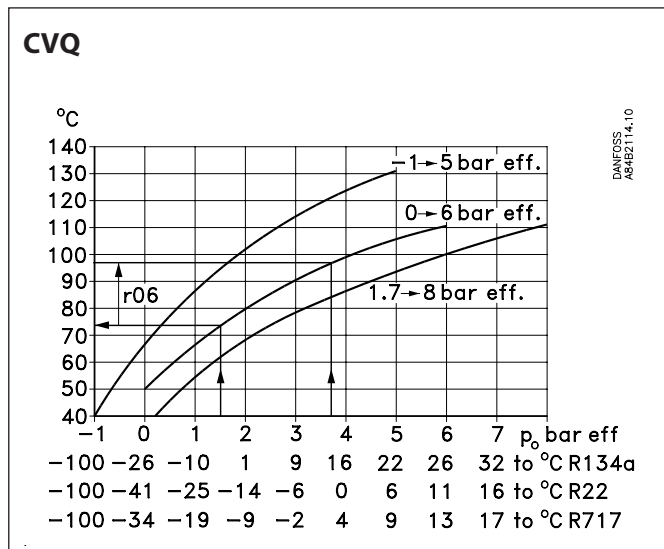

All the curves shown are approximate.

The two curves are shown with the valve's spring setting equaling the factory setting. If the spring setting is changed to a higher pressure, the curve will be displaced correspondingly to a higher temperature.

Example

CVQ type = 0-6 bar

Refrigerant = R₇₁₇

A constant evaporating temperature or input pressure to the valve of -9°C (2 bar) is required.

According to the CVQ curve this will require a temperature in the actuator of 80°C.

Set the valve's basic temperature reference at 80°C.

When the valve has reached its working temperature, it may be necessary to fine-adjust the setting from the system's manometer.

Data

Supply voltage	24 V a.c. +/-15% 50/60 Hz, 80 VA (the supply voltage is galvanically separated from the input and output signals)	
Power consumption	Controller Valve	5 VA 75 VA
Input signal	4-20 mA, 0-20 mA, 0-10V d.c. or 2-10 V d.c.	
Actuator	Input	Temperature signal from sensor in actua- tor
	Output	Pulsating 24 V a.c. to actuator
Data communication	Possible to connect a data communication module	
Ambient temperature	During operation	-10 - 55°C
	During transport	-40 - 70°C
Enclosure	IP 20	
Weight	300 g	
Mounting	DIN rail	
Display	LED, 3 digits	
Terminals	max. 2.5 mm ² multicore	
Approvals	EU Low Voltage Directive and EMC demands re CE-marking complied with. LVD-tested acc. to EN 60730-1 and EN 60730- 2-9 EMC-tested acc. to EN 50081-1 and EN 50082-2	

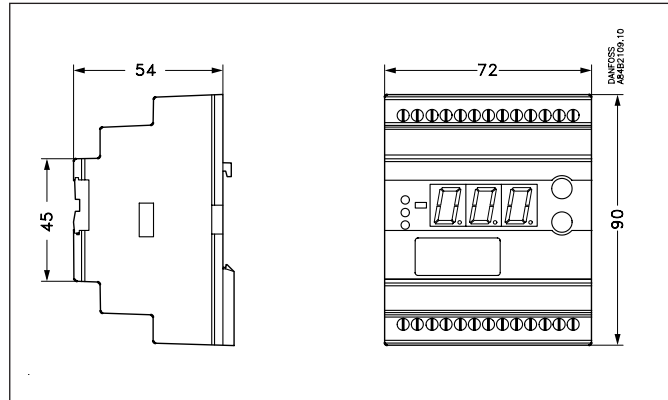

Ordering

Type	Function	Code No.
EKC 366	Interface module	084B7076
EKA 173	Data communication module (ac- cessories), (FTT 10 module)	084B7092
EKA 174	Data communication module (ac- cessories), (RS 485 module) with galvanic separation	084B7124

Valves:

Kindly refer to catalogue RK0YG

Connections

Necessary connections

Terminals:

- 25-26 Supply voltage 24 V a.c. 80 VA
- 17-18 Signal from NTC sensor in valve
- 23-24 Supply to valve's PTC resistance

Control signal, if applicable (see also o10)

Either terminals:

- 15-16 Voltage signal
- or
- 18-19 Current signal

Data communication, if applicable

Terminals:

- 3-4 Mount only, if a data communication module has been mounted.

It is **important** that the installation of the data communication cable be done correctly. Cf. separate literature No. RC8AC...

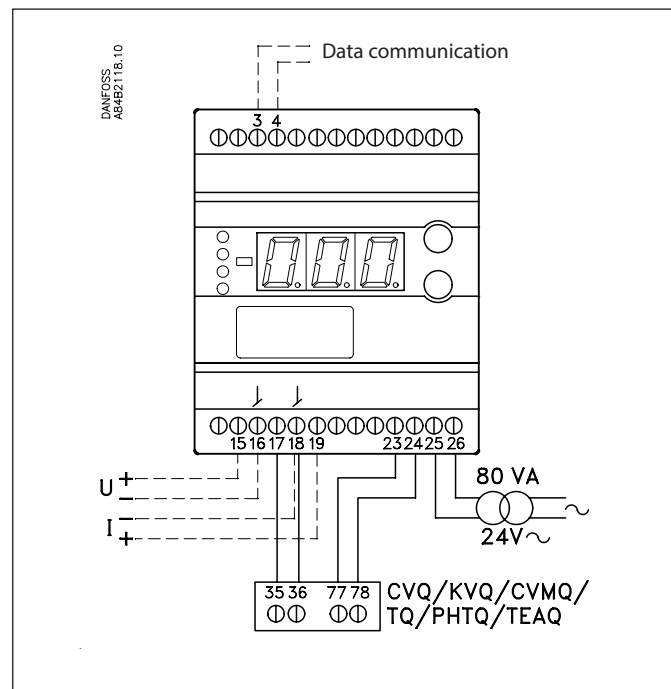

Data communication

This page contains a description of a few of the possibilities you will have when the controller is provided with data communication.

If you want to know more about operation of controllers via PC, you may order additional literature.

Examples

Each controller is provided with a plug-in module.

The controllers are then connected to a two-core cable.

Up to 60 controllers may be connected to one cable.

This cable is also connected to a gateway type AKA 243.

This gateway will now control the communication to and from the controllers.

It will collect temperature values and it will receive alarms. When there is an alarm the alarm relay will be activated for two minutes

The gateway can now be connected to a modem.

When an alarm occurs from one of the controllers, the gateway will - via the modem - make a phone call to the service company.

At the service company a modem, gateway and PC with system software type AKM have been installed.

All the controllers' functions can now be operated from the various menu displays.

The programme will for example upload all the collected temperature values once a day.

Example of menu display

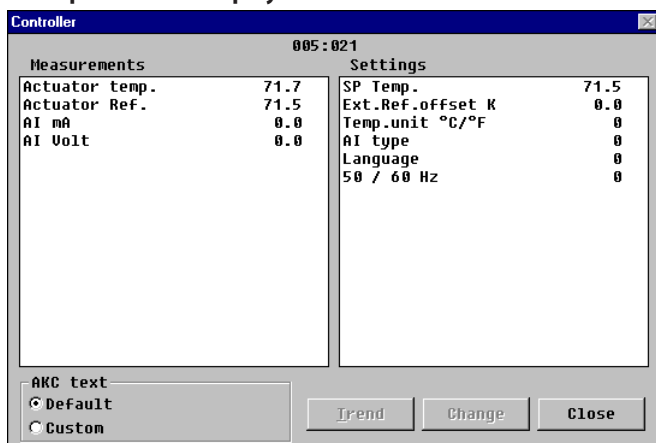

Measurements are shown at one side and settings at the other.

You will also be able to see the parameter names of the functions on page 3.

With a simple change-over the values can also be shown in a trend diagram.

If you prefer to see the earlier temperature measurements, you may upload a log collection.

Alarms

If the controller is extended with data communication, it will be possible to define the importance of the transmitted alarms.

The importance is defined with the setting: 1, 2, 3 or 0. When the alarm then arises at some time, it will result in one of the following activities:

1 = Alarm

The alarm message is sent off with alarm status 1. This means that the gateway that is the master in the system will have its alarm relay output activated for two minutes. Later, when the alarm ceases, the alarm text will be retransmitted, but now with status value 0.

2 = Message

The alarm text is transmitted with status value 2. Later, when the "message" lapses, the alarm text is retransmitted, but now with status value 0.

3 = Alarm

As "1", but the master gateway's relay output is not activated.

0 = Suppressed information

The alarm text is stopped at the controller. It is transmitted nowhere.

ENGINEERING
TOMORROW

Danfoss

Danfoss can accept no responsibility for possible errors in catalogues, brochures and other printed material. Danfoss reserves the right to alter its products without notice. This also applies to products already on order provided that such alternations can be made without subsequential changes being necessary in specifications already agreed.
All trademarks in this material are property of the respective companies. Danfoss and Danfoss logotype are trademarks of Danfoss A/S. All rights reserved.
